

2026

***OEM & Aftermarket
Catalog***



**GLOBETECH
MANUFACTURING**

Thank you for your
continued support.

Trailer Parts & Accessories	Page	Electrical Products	Page	Air Products	Page
Document Holders	2, 3	ABS Cables	57	Spring Breaks	91-94
Louvered Vents	4	Non ABS Cables	58-59	Diaphragms	95
Manifest Box	4	Plugs	60	Chamber Clamps	95
Placard Holders	5-6	Sockets	61	Standard Air Coils	96-97
Conspicuity Tape	7	Connectors	62	Extreme Weather Air Coils	98
Door Hardware	8-15	Junction Box	62	Air-Electric 3 to 1 Combo	99
Corner Irons	14	Adapters	63	Bulk Rubber Air Hose	100
Corner Cap	14	Protector Boots	63	Rubber Air Brake Hose Assemblies	101
Grab Handles	15	Rubber Cushion Clamps	64	Rubber Air Hose D.O.T. Brass Hardware	102-103
Registration Holders	16	Wire Clip	64	Nylon Air Hose Tubing	104
Vinyl Pouch	16	Rubber Grommet	64	Nylon Air Hose D.O.T. Brass Hardware	105
 		Noseboxes	65	Quick Connect Push-In Hardware	106
Mud Flaps & Accessories		Circuit Breaker	66	Swivel Kits	105
G-Force Aerodynamic Mud Flaps	18	Ground Kits	66	Drain Valve	105
3/16" Diamond Rubber A/V Mud Flaps	19	Brush Kits	66	Nylon Tube Cutter	105
Rubber Material Specification	20	Poly Looms	67	Clamping Studs	106
Armor Guard Rubber Mud Flap	21	Socketbreakers	67	Crimping Hose Ends	106
Economy Chevron Rubber Mud Flap	22	Rubber Tractor Lamps	68	Slide Bars	107
Standard Rubber Mud Flap	23	License Plate Light	68	Tender Kits	107
Xtreme Rubber Mud Flap	24	 		Suspender Springs	107
Heavy Duty Anti-Spray Rubber Mud Flaps	25	Wheel End Products		Hose Separators & Holders	108
Quick Change Anti-Spray Mud Flap	25	Aluminum Alloy Hub Caps	69-71	Pogo Sticks	109
Quick Mount Anti-Sail Mud Flap	26	Hubodometer Brackets	71	Clevis Assemblies	110
Raintrapper Mud Flap	26	Pro Par Style Hub Caps	72	Slack Adjusters	111-119
Raised Molded Rubber Mud Flap	32	Window Kits & Plugs	73	Valves	120-130
Raised Molded Rain Guard Mud Flap	32	Hub Cap Gaskets	74	Air Dryers	131-133
Tireplast Mud Flap	28	Tempbolts	75	Gladhands	134-136
Mid Guard Mud Flap	27	Inner/Outer Wheel Hardware	76	Gladhand Accessories	136-140
Side Skirt Mud Flap	27	Hub Cap Hardware	77	Brake Shoe Hardware Kits	141
Colored Poly Mud Flap	27	PSI Hub Caps	78	 	
Silk-Screen Logo Rubber	30	Tire Inflation Hose	79	Miscellaneous	
Hot Stamp Logo Poly	31	Inner Tube	80	King Pin Locks & Gladhand Locks	143
Polyguard Standard	29	Tire Repair Tool Kit	80	Fifth Wheel Puller	144
Polyguard Plus Anti-Spray Mud Flaps	29	Tire Inflator Kit	81	Coil Rack	144
Polyguard Plus HD Anti-Spray Mud Flaps	29	Tire Chucks/Tire Gauges	81	Slick Discs	144
Stock Logo Mud Flaps	36,37	Valve Stems	82	Triangle Kits	145
Custom Logo Mud Flap Forms	34-35	Valve Stem Caps	83	Lock Rod Assembly	146
Wheel Chocks	38	Standard Bore Valve Tool	83	Cross-Reference Page	147-150
Trailer Bumpers	9-41	Freeze Plugs	84	Index	151-157
Laminated Bumpers	42	 		Notes	158-159
Door Bumpers	42	Gen2 ABS		Warranty	160
Bar Type Mud Flap Hangers	43-44	4S/1M Comparison	83-86		
Mounting Brackets for Hangers	45	ECU's & GEN2 2S/1M	87		
Mud Flap Bolt Kits	46	GEN2 ABS Parts List	88		
Bulk Display Hangers	46	GEN2 ABS Parts List	89-90		
Conspicuity Accessories	47				
Spring Loaded Brackets	48-50				
Quarter Fenders	51-52				
Quarter Fender Top Flaps	53				
Quarter Fender Hardware	53-54				
Quick Reference Guide	56				

all references to competitors' part numbers
are for cross reference purposes only



TRAILER PARTS & ACCESSORIES

Trailer Parts & Accessories

DOCUMENT HOLDERS



GT-1001

- UV-resistant Dow Corning CALIBRE polycarbonate lens
- EPDM rubber seal for weather proofing

Part Number	Description	Replaces Betts#
GT-1001	Plastic document holder outside: 6" x 5" x 1-2/3" inside: 4-1/4" dia, 1" depth	PS-1
GT-1001S	O-ring seal for GT-1001	BTL-820012
GT-1004	Replacement lens & seal kit	BTL-71P5



GT-1007

- UV-resistant Dow Corning CALIBRE polycarbonate lens
- Water resistant seal, retaining spring, locking design

Part Number	Description	Replaces Trucklite#
GT-1007	Twist lock document holder w/wire outside: 6" x 5" x 2-1/2" inside: 3-3/4" dia, 1" depth	97960
GT-1008	Replacement lens & seal kit	TL-97962



GT-1003

- EPDM rubber caps for UV-resistance
- Stainless steel cable eliminates loss of end caps
- Pre-drilled mounting brackets

Part Number	Description	Replaces Fleet Engineers#
GT-1003	Tube style document holder w/ rubber end caps, 9" length, 1-1/2" diameter, 4" bracket height	022-01190
GT-1005	Replacement cap For GT-1003	



GT-1006

- Stainless steel hardware
- Poron gasket

Part Number	Description	Replaces James King#
GT-1006	Security box, die cast outside: 7" x 5-1/4" x 2" Clipboard: 3-1/2" x 5-1/4"	Model 300
GT-1009	Replacement lid kit for GT-1006	

all references to competitors' part numbers are for cross reference purposes only



DOCUMENT HOLDERS



GT-1035

- High-tech plastic is unaffected by weather, chemicals, or corrosion
- Rainshield lid & water resistant seal
- Side clips prevent accidental opening

Part Number	Description	Replaces James King#
GT-1035	Xenoy document holder overall: 7" x 5-1/4" x 2" inside: 5" x 3-1/2" x 1"	Model 350
GT-1035B	Document holder, body only for GT-1035	-
GT-1035L	Replacement Lid Kit for GT-1035	-



GT-1050

- Holds papers and binders up to 10" x 14"
- Sliding lid with rainshield
- Internal document shelf

Part Number	Description	Replaces James King#
GT-1050	Large plastic record holder outside: 16" x 11-1/2" x 1-1/2" inside: 14" x 10" x 1-1/2"	Model 500
GT-1050L	Replacement Lid Kit for GT-1050	-



GT-1055

- Flip open lid features triple latch for secure close
- Interior clip & document shelf

Part Number	Description	Replaces James King#
GT-1055	Flip plastic record holder outside: 15" x 10" x 1-1/4" inside: 12-1/4" x 9-1/2" x 3/4"	Model 550
GT-1055L	Replacement Lid Kit for GT-1055	-

all references to competitors' part numbers are for cross reference purposes only



LOUVERED VENT



GT-1105

- Louvered Aluminum

Part Number	Description	Replaces Fleet Eng.#
GT-1105	Slide by vent	024-03000
GT-1105B	Slide by vent, black	-

MANIFEST BOX



GT-1002

- Lightweight aluminum body, stainless steel hinge & latch
- Outside: 13" x 8" x 1-1/2"
- Inside: 11-1/2" x 6-1/2" x 1-1/4"
- Available with custom logo

Part Number	Description	Replaces Fleet Engineers#	Replaces James King#
GT-1002	Aluminum manifest box	022-01087	Model 200
GT-1002WHT	White manifest box	-	-



GT-04400035

- Pre drilled to hold GT-1002 manifest box
- Powder coated finish

Part Number	Description	Replaces Wabas
GT-04400035	Aluminum pan for GT-1002	04400035

DISCONTINUED

all references to competitors' part numbers are for cross reference purposes only



PLACARD HOLDERS



GT-1100

- Louvered Aluminum



GT-1102

- Plastic

Part Number	Description	Replaces
GT-1100	Standard aluminum placard holder w/ stainless clip & back plate	80SM-4CC Labelmaster
GT-1101	Standard placard holder, white w/ stainless clip & back plate	-
GT-1102	Plastic placard holder	JJK2-TPH JJ Keller



GT-1100A



GT-1103

Part Number	Description	Replaces Labelmaster#
GT-1100A	Aluminum placard holder, angle cut w/ back plate	80SM-P
GT-1101A	White placard holder, angle cut W/ back plate	-
GT-1103	Aluminum face	4-TPH
GT-1111	Stainless Steel clip	



GT-1111
Stainless Steel replacement clip



GT-1150

GT-1150 (Aluminum) GT-1150W (White)	GT-1151 (Aluminum) GT-1151W (White)
<ol style="list-style-type: none"> Explosive Flammable Gas Corrosive Dangerous Flammable Non-Flammable Gas Oxidizer Poison Radioactive Blank White 	<ol style="list-style-type: none"> Corrosive Flammable Gas Radioactive Flammable Plain White Dangerous Oxidizer Non-Flammable Gas Poison
Replaces Labelmaster #81-10F0	Replaces Labelmaster #81-8F0

all references to competitors' part numbers are for cross reference purposes only



PLACARD HOLDER

GT-1108 Aluminum
Placard Holder Small 5x7

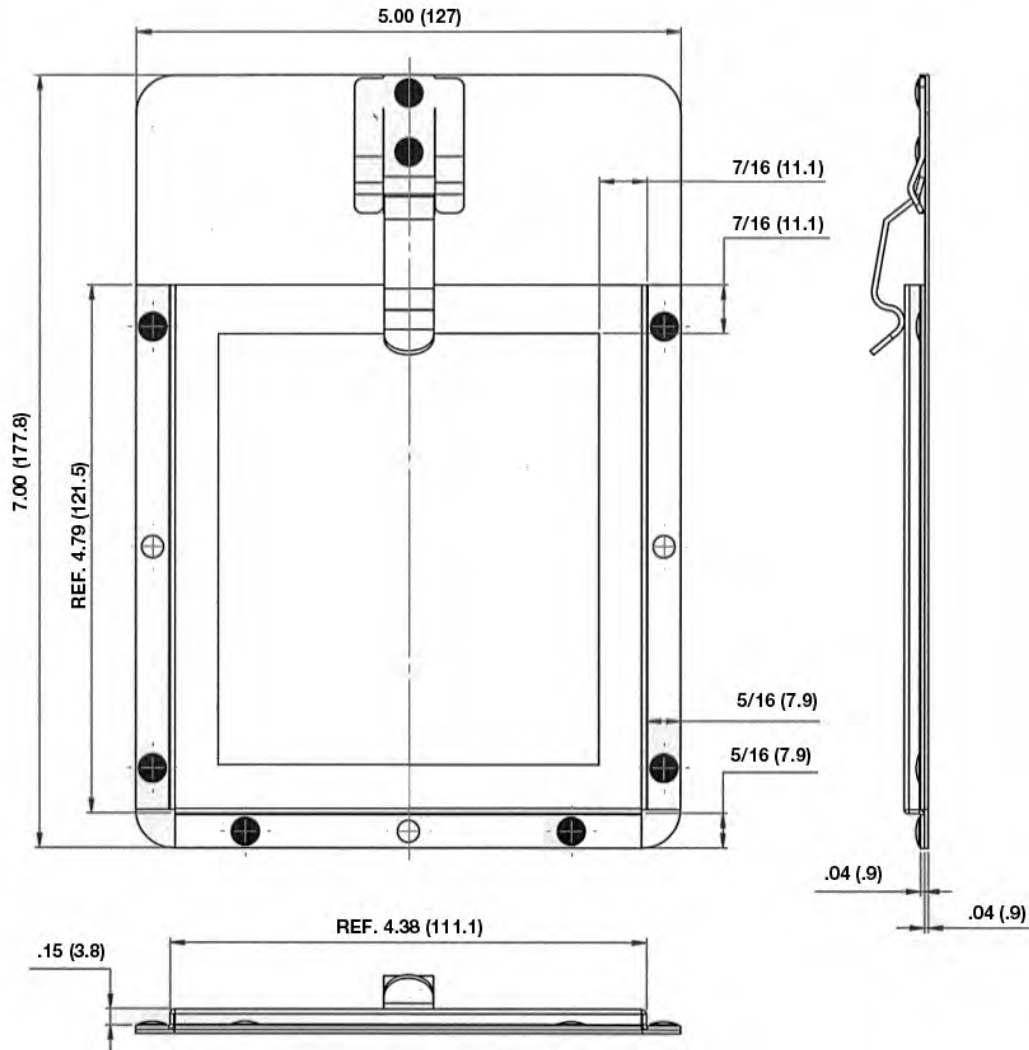
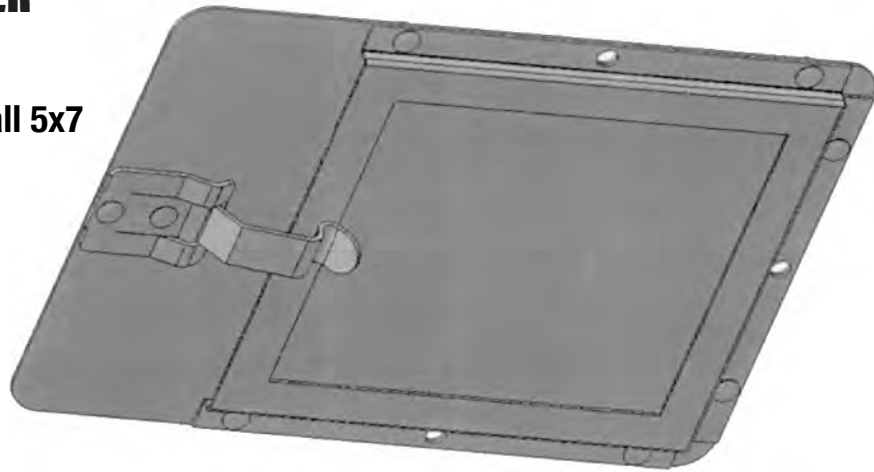

all references to competitors' part numbers
are for cross reference purposes only



CONSPICUITY TAPE BENEFITS

- DOT tape is certified and guaranteed to meet and exceed NHTSA requirements
- Durable – resists weather, dirt and aging
- Aggressive adhesive: DOT Specs
- Non – corroding
- Strong and durable for easy application to smooth surface
- New thin, flexible prismatic for smooth surface, and around rivets and corners



COLOR PLOTS

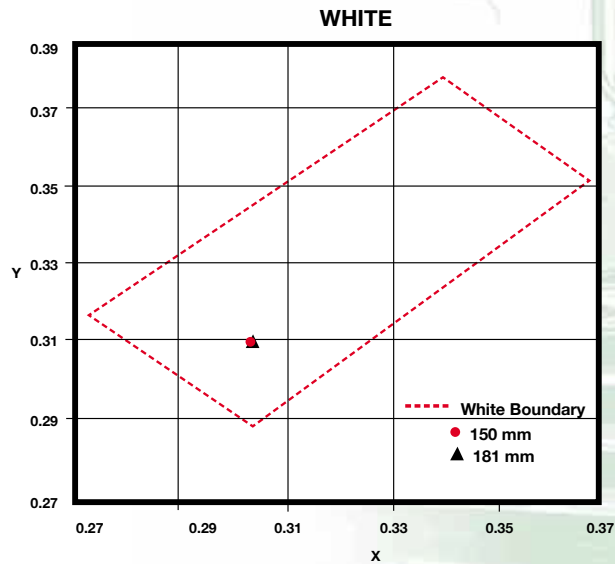
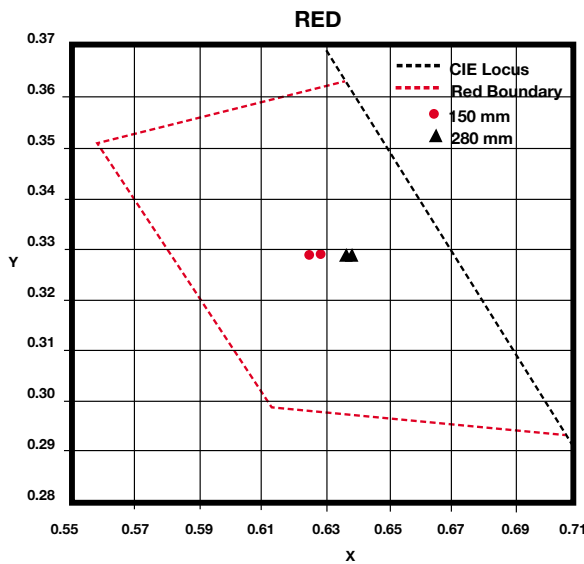

Part No.	Color	Width	Unit	Length	Quantity	Replaces 3M ID
GT-27003	Red & White	2 inch	6" Red x 6" White Roll	150 ft	1	75-0301-6343-2
GT-27004	Red & White	2 inch	11" Red x 7" White Roll	150 ft	1	75-0301-6340-8
GT-27005	White	2 inch	Roll	150 ft	1	75-0301-6345-7
GT-27006	Yellow	2 inch	Roll	150 ft	1	
GT-27007	Orange	2 inch	Roll	150 ft	1	

all references to competitors' part numbers are for cross reference purposes only



TRAILER PARTS & ACCESSORIES

Trailer Parts & Accessories

HOLDBACKS

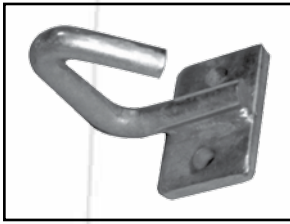

Part Number	Description	Replaces Wabash #	
GT-1301	Door holdback hook, galvanized mounting plate: 2" x 2-3/16" hook height: 2-1/4"	06300015	

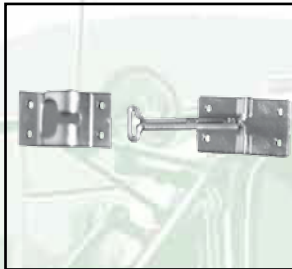

Part Number	Description	Replaces Wabash #	Replaces Fleet Engineers #
GT-1302	"T" type door holdback T bar length: 4", base: 1-3/4" x 3"	06300028	022-01022
GT-1326	"T" type door holdback T bar length: 6", base: 1-3/4" x 3"	-	022-1024



Part Number	Description	Replaces Wabash #	
GT-1303	Stainless steel spring holdback width: 11-1/2", length: 20-1/2"	06300094	



Part Number	Description	Replaces Wabash #	
GT-1306	Holdback hook #XCD-0262-1, galvanized	06300119	

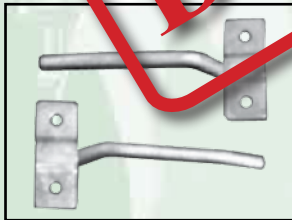

Part Number	Description	Replaces Wabash #	Replaces Eberhard #
GT-1307	Door holdback post, galvanized mounting plate: 3-1/4" x 1-1/4" post length: 6-3/4"	06300693	6602-50

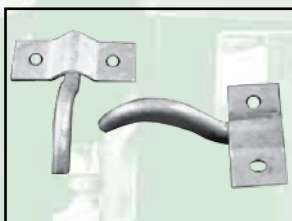

Part Number	Description	Replaces Wabash #	Replaces Eberhard #
GT-1312	Door holdback post, galvanized mounting plate: 1-1/4" x 3-3/16" post length: 4-11/32"	06301964	6603-50

DISCONTINUED

all references to competitors' part numbers are for cross reference purposes only



LOOPS & SNAPS

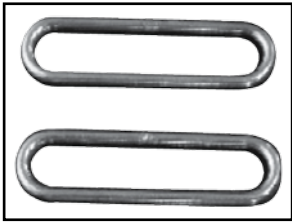

Part Number	Description	Replaces Wabash #	Replaces Eberhard #
GT-1313	4" chain loop	06302523	6601-3



Part Number	Description	Replaces Wabash #
GT-1314	Galvanized snap, 1/2"	06300058

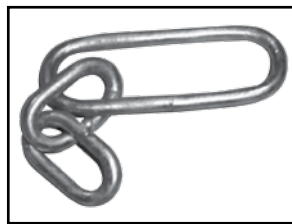

Part Number	Description	Replaces Wabash #
GT-1316	4" loop, galvanized, 2 small links	06300985

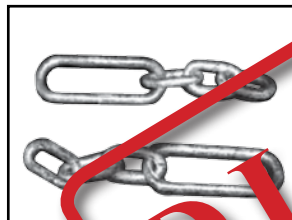

Part Number	Description	Replaces Wabash #
GT-1317	4" holdback loop, galvanized, 3 small links	06302613

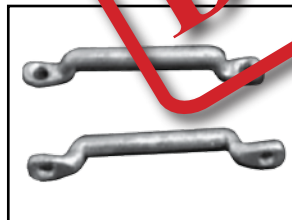

Part Number	Description	Replaces Wabash #	Replaces Fleet Engineers #
GT-1300	Footman loop, galvanized overall length: 3-1/2", C-C: 2-3/4"	A1300017	021-00043



Part Number	Description	Replaces Wabash #	Replaces Eberhard #
GT-1305	Holdback loop, galvanized large link: 4", 4 small links	06300118	6608-1 (3" large link)

all references to competitors' part numbers are for cross reference purposes only



DOOR SOCKETS/PLUNGER

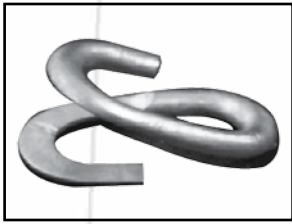

Part Number	Description	Replaces Wabash #	Replaces Fleet Engineers #
GT-1304	Loop attach link #DCC-07478-1 galvanized	06300117	021-00053



Part Number	Description	Replaces Wabash #	Replaces ORR #
GT-1308	Plunger, galvanized, 1-5/8"	06300805	H9013



Part Number	Description	Replaces Wabash #
GT-1315	Socket w/o rubber insert galvanized	06300844



Part Number	Description	Replaces Wabash #	Replaces Eberhard #
GT-1309	Female rubber socket w/ steel insert	06301166	1-666-2 (female portion only)



Part Number	Description	Replaces Wabash #	Replaces Eberhard #
GT-1310	Male insert for GT-1309	06301167	1-666-2 (male portion only)



Part Number	Description	Replaces Wabash #
GT-1318	Rubber insert	06301217

DISCONTINUED

all references to competitors' part numbers are for cross reference purposes only



DOOR HARDWARE



Part Number	Description	Replaces Fleet Engineers #
GT-1323	Door holdback, 6" loop used in post style holdback kits	022-01078



Part Number	Description	Replaces Fleet Engineers #
GT-1324	5" footman loop 5" overall length 4-1/4" C-C	022-00628

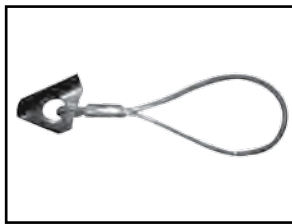

Part Number	Description	Replaces Fleet Engineers #
GT-1327	Holdback Loop, Fruehauf style 8-1/2" overall length 2-1/4" x 2/3" base plate	022-00487



Part Number	Description	Replaces Wabash #	Replaces Fleet Engineers #
GT-1328	Door holdback w/3 chain links & HD strap	525461	021-00050



Part Number	Description	Replaces Todco
GT-1400	End hinge, T-style, zinc-plated, for roll up doors	69035



Part Number	Description	Replaces Todco
GT-1401	Center hinge, zinc-plated, for roll up doors	61196

all references to competitors' part numbers are for cross reference purposes only



TRAILER PARTS & ACCESSORIES

DOOR HARDWARE

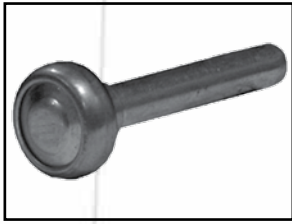

Part Number	Description	Replaces Todco#
GT-1402	1" steel roller	61174

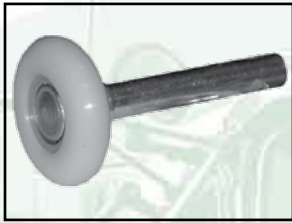

Part Number	Description	Replaces Todco #
GT-1403	2" nylon roller	70125

KIT REPLACEMENTS

Create kits similar to Fleet Engineer kits with standard Globetech components:



GT-1331

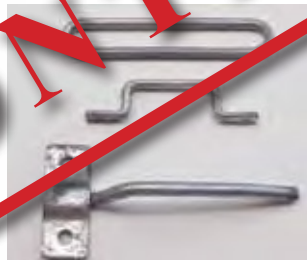

GT-1332



GT-1333



Globetech Kit	Globetech replacement part numbers for kit	Description	Replaces Fleet Engineers kit#
GT-1331	(1) GT-1300 and (1) GT-1328	Handle style anchor, chain, lap link & snap	021-00051
GT-1332	(1) GT-1324, (1) GT-1313 and (1) GT-1307	Handle, post holdback & 4" loop	021-00373
GT-1333	(1) GT-1324, (1) GT-1323 and (1) GT-1307	Handle, post holdback & 6" loop	021-00374

all references to competitors' part numbers are for cross reference purposes only



WABASH STYLE HOLDBACK OBLONG LOOP AND CHAIN KIT

GT-1329 Oblong Loop and Chain
Replaces WAB06302250

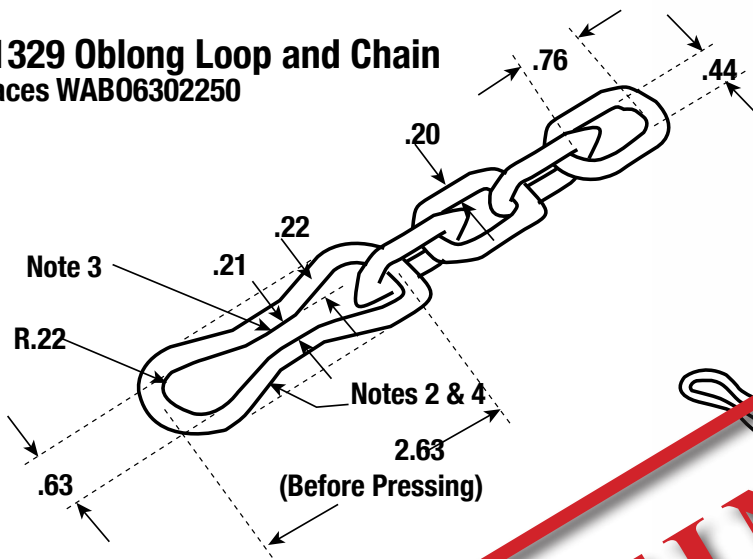

GT-1311 Hook
Replaces WAB06302200



Notes:

1. Four 4/0 Passing links-welded
2. Weld oblong link-grind so there is maximum .03 high flashing
3. Press in sides of oblong link to within .20 of each other
4. Oblong link weld should be free of cracking after pressing

GT-1334 Kit
Replaces WAB06302201

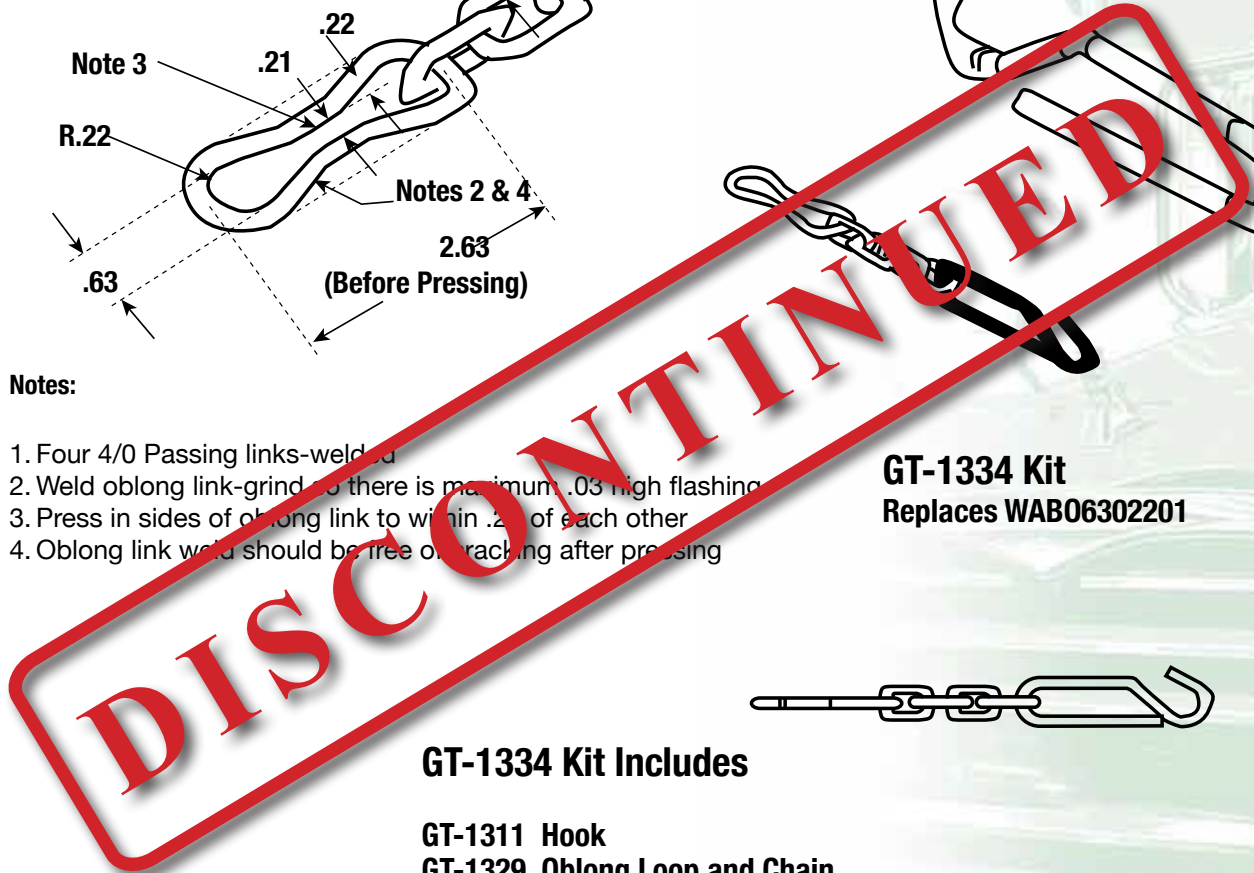

GT-1334 Kit Includes

GT-1311 Hook
GT-1329 Oblong Loop and Chain

GT-1336 Kit
Wabash Style Vent Door Holdback Loop
Replaces WAB06303036

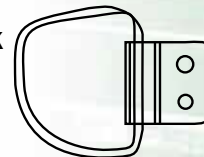

all references to competitors' part numbers are for cross reference purposes only



TRAILER PARTS & ACCESSORIES

Trailer Parts & Accessories

CORNER IRONS



High strength, drop forged steel construction

GT-1201 – OEM
GT-1202 – Aftermarket

Part Number	Replaces	Size	Weight
GT-1201	B24878	8"x6"x1-1/2"	2.7lb
GT-1202	B2485aa	12"x12"x1-1/2"	4.5lb

GT-1200P-CORNER CAP FREUHAUF STYLE

Replaces: Freuhauf
- FruWC F9 Plastic
nylon



DISCONTINUED

VISIT US ONLINE AT GTMANUFACTURING.COM

USA MANUFACTURING

OEM QUALITY TRAILER PARTS

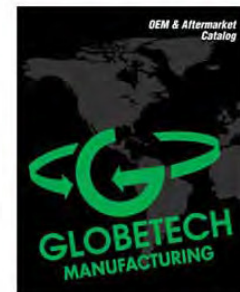

all references to competitors' part numbers are for cross reference purposes only



GRAB HANDLES

Part Number	Description
GT-5377	18"
GT-5378	24"



GT-5377



GT-5378

STEEL GRAB HANDLE

- Available in zinc and chrome finishes

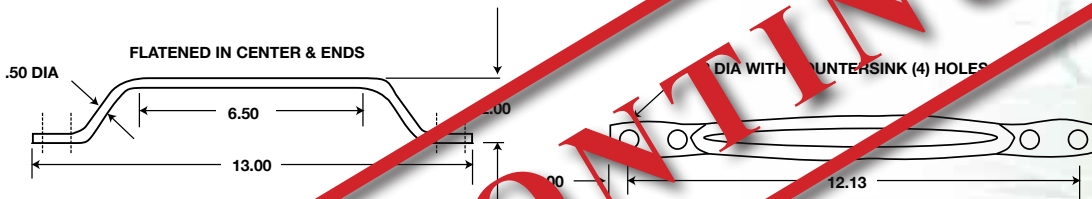

Part Number	Weight(lbs.)	Popularity Code	Construction	Cross Reference
GT-1114	.80	A	Zinc plated steel	Eberhard #4300 zinc
GT-1114C	.80	A	Chromed steel	Eberhard #4300 chrome

ALUMINUM GRAB HANDLE

- Aluminum construction

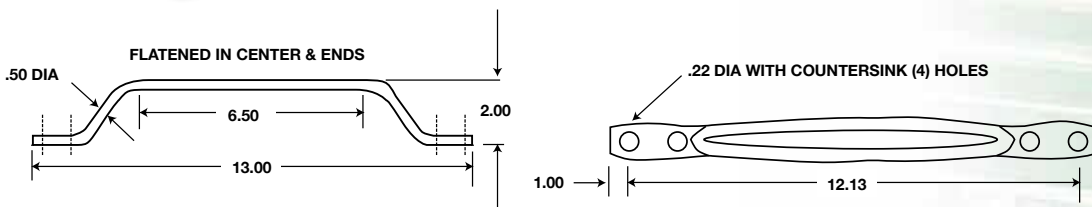

Part Number	Weight(lbs.)	Popularity Code	Construction
GT-1124	.80	A	aluminum

all references to competitors' part numbers are for cross reference purposes only



TRAILER PARTS & ACCESSORIES

Trailer Parts & Accessories

REGISTRATION HOLDER

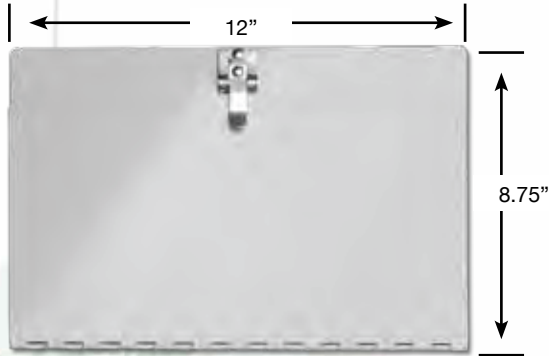

GT-1106

NEW HOT ITEMS!

- Aluminum
- Powder coated finish

Part Number	Description
GT-1106	8.75" x 12" Replaces JJ Keller JJK 1RSP-DD
GT-1107	10.5" x 13" Registration Holder
GT-1111	Stainless Steel Clamp

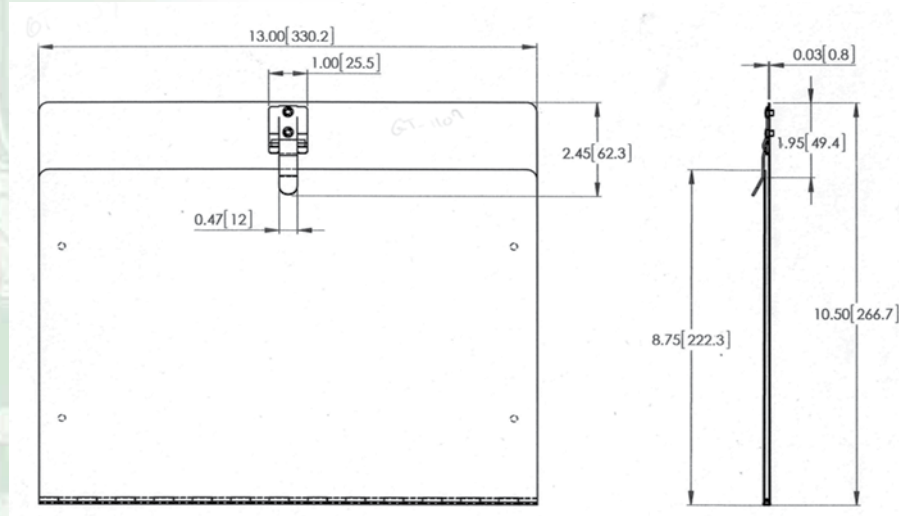

GT-1107

GT-1011 WATER PROOF VINYL POUCH

Replaces Grote 43411-3

- All weather protection for permits, licenses, inspection stickers
- Self-sealing zipper protects from moisture and dirt
- Mounting: Four brass eyelets
- Sizes: 5-3/4" Wx8-1/4" L



all references to competitors' part numbers are for cross reference purposes only



BRACKETS • MUD FLAPS • QUARTER FENDERS

RUBBER & POLY CUSTOM MUD FLAPS

all references to competitors' part numbers
are for cross reference purposes only

www.globetechmanufacturing.com



MUD FLAPS & ACCESSORIES

G-FORCE AERODYNAMIC MUD FLAPS

The Ultimate Aerodynamic Mud Flap Reduces Fuel Costs!

Mud Flaps & Accessories

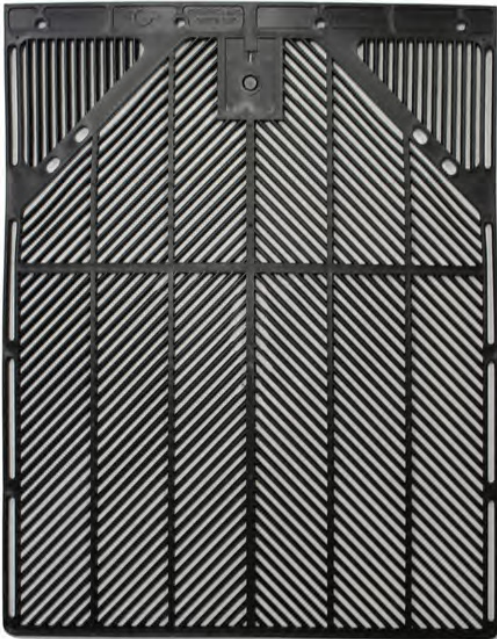

Part Number	Description	Weight Per Pair
GT-2424GFB	24x24 G-Force Aerodynamic Flap	10 lbs.
GT-2430GFB	24x30 G-Force Aerodynamic Flap	12 lbs.

- Reduces Fuel Costs
- Reduces Spray
- Anti-Sail
- Cold Temps to -42 degrees
- Optional LED light

Endorsed by Wright-Patterson Air Force Base

"Symmetric wing shaped airfoil design for each rib provides lowest drag coefficient optimizing air flow and improving fuel efficiency. Aerodynamic design allows air to through reducing movement of mud flaps at higher speeds maintaining their protective function. Vertical and angled ribs help to dissipate moisture and debris in a safe manner at all weather conditions and speeds. The G-Force 400 is weighted at an optimal 4.5 pounds and will not flex, bend or rotate at higher speeds. As an engineer I endorse this product due to its aerodynamic angled rib foil design allowing air to pass through yet keeping its protective function giving customers a fuel efficient durable mud flap."

John G. Czikk, C-130 Avionics Modernization Program Engineer
Wright Patterson Air Force Base, Dayton, Ohio

G-Force Aerodynamic Mud Flaps are offered as standard non-logo mud flaps only.

For current availability, use the standard G-Force part numbers listed above. Custom logo printing is no longer offered for this product line.

all references to competitors' part numbers are for cross reference purposes only



3/16" ECONOMY DIAMOND RUBBER AV MUD FLAPS



Globetech's Diamond Mud Flaps

Globetech uses the finest material available to mold its Diamond mud flaps. These are very popular mud flaps for everyday use including off road and over the road applications.

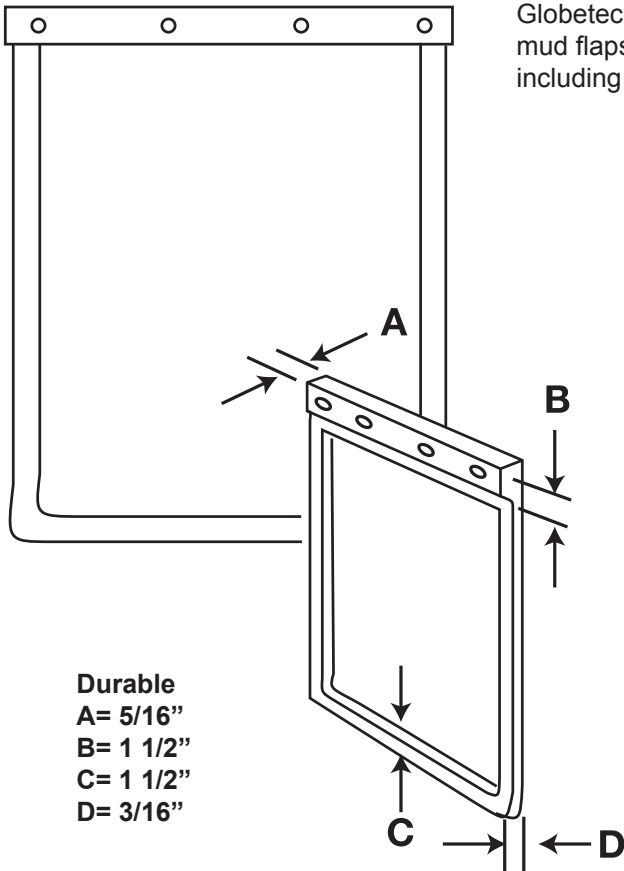

Durable
 A= 5/16"
 B= 1 1/2"
 C= 1 1/2"
 D= 3/16"



NEW PART

MOLDED IN USA

Mud Flaps & Accessories

Part Number	Description	Weight Per Pair
GT-2424D	24x24 Diamond Economy Mud flap	8 lbs.
GT-2430D	24x30 Diamond Economy Mud flap	12 lbs.
GT-2436D	24x36 Diamond Economy Mud flap	14 lbs.



MUD FLAPS & ACCESSORIES

ARMOR GUARD COMPOUND

UNVULCANIZED FRICTION COMPOUND



Globetech Compound 6807

Typical Properties:

Density:	1.16± .04 gms/cm
Shore A Durometer:	70 Duro ± 8
Tensile Strength:	2000 Minimum
Elongation	300% Minimum

Globetech Material Reinforced Ultimate Tear Strength!

Basic Material is commercial productive tire tread compound or similar. Reinforced with polyester and nylon fiber. SBR/NR

ASTM D624 - 00(2012)

Standard test method for tear strength of conventional vulcanized rubber and thermoplastic elastomers

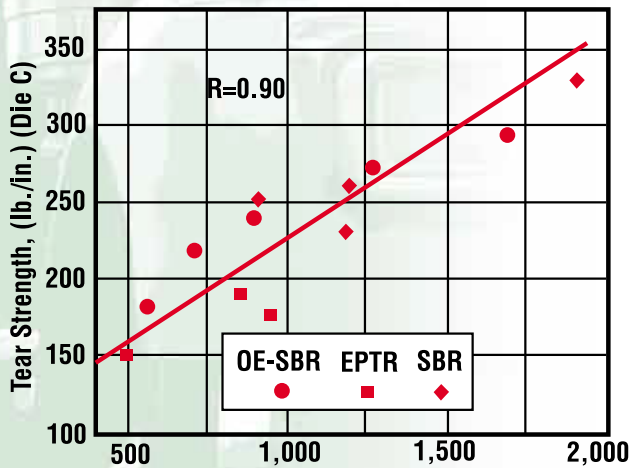

Plot of ASTM Die C Tear Strength as a Function of Stress at 300% Elongation

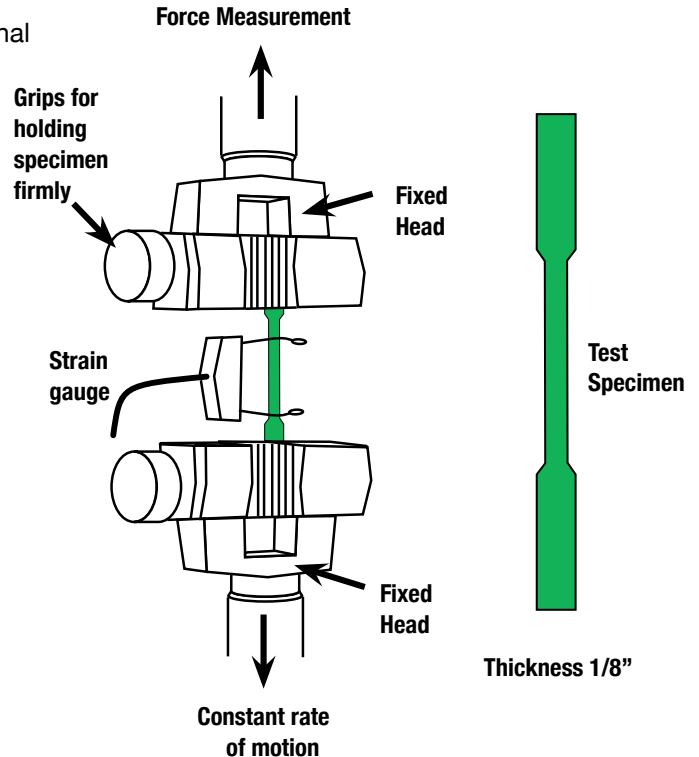

all references to competitors' part numbers are for cross reference purposes only



ARMOR GUARD RUBBER MUD FLAPS

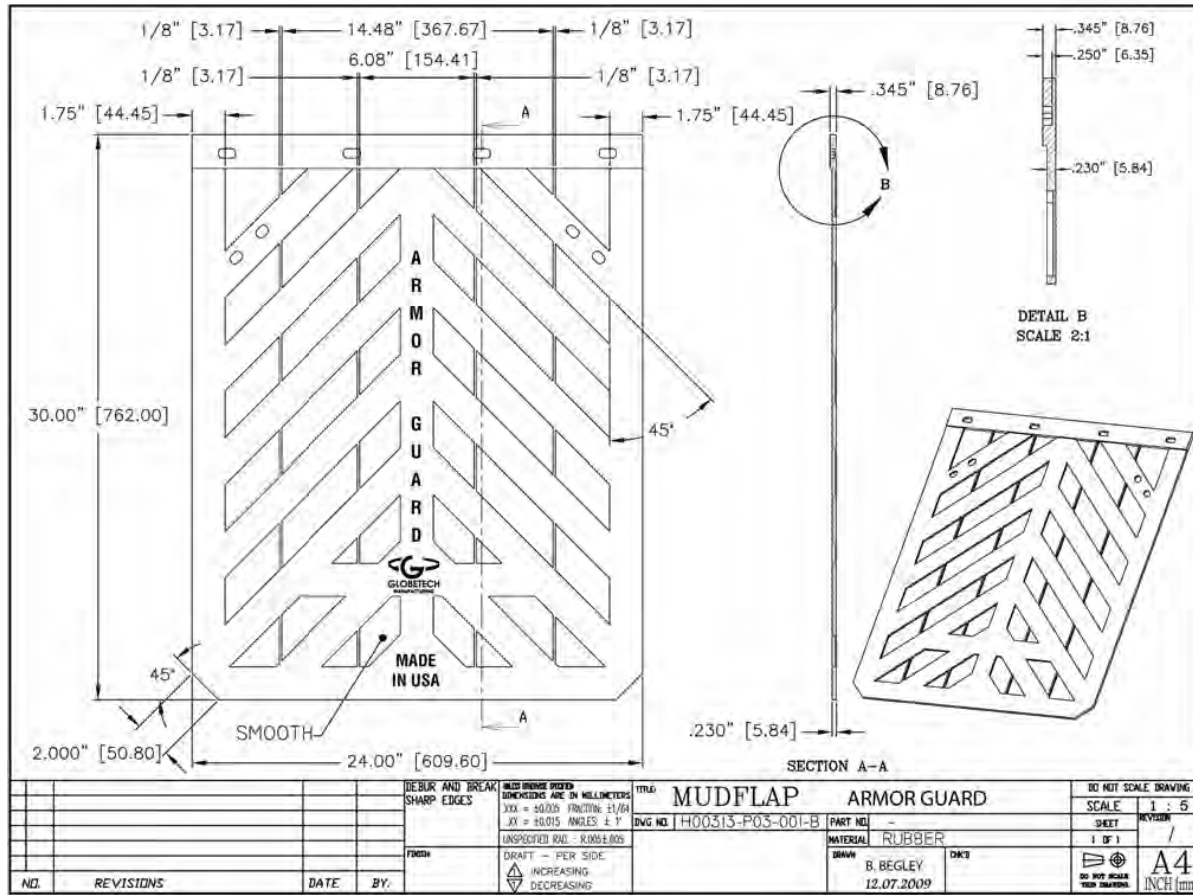

Mud Flaps & Accessories

RUBBER MUD FLAPS



ARMOR GUARD MUD FLAP

The Armor Guard splash guard is made from 100% fiber reinforced rubber. The header is molded thicker to resist tearing through normal use. The top corners can be cut to fit standard 45 degree angle brackets. While the bottom can be cut down when a shorter flap is needed.

100% High Tear Strength Best Flap On The Market!

Part Number	Description	Weight Per Pair	Replaces No.
GT-2424CD	24x24 Armor Guard Domestic	12 lbs.	062424
GT-2430CD	24x30 Armor Guard Domestic	14 lbs.	062430
GT-2436CD	24x36 Armor Guard Domestic	16 lbs.	062436

all references to competitors' part numbers are for cross reference purposes only



MUD FLAPS & ACCESSORIES

STANDARD CHEVRON MUD FLAPS



CHEVRON MUD FLAP

This is our economy least expensive mudflap. These flaps are thinner and molded from natural rubber and reinforced with "Small Fibers". This flap has a High tear strength! **Look for the  logo!** Many import chevrons are not made by Globetech and tear easy.

Part Number	Description	Weight Per Pair
GT-2424C	24x24 Chevron Economy Mud flap	10 lbs.
GT-2430C	24x30 Chevron Economy Mud flap	12 lbs.
GT-2436C	24x36 Chevron Economy Mud flap	14 lbs.

ASTM STANDARD TESTING

- **Hardness: 80A**
- **Elongation: 200%**
- **Tensile: 4.2 MPA (609)**
- **Tear Strength: K/NR 30 (171)**
- **Spec. Gravity 1.39**

Tear Resistance

The resistance to growth of a nick or cut when tension is applied to the cut specimen. (ASTM D-624.)

Tensile Strength

The tensile strength of a rubber compound is its resistance to rupture under tension. It is measured as strength at break and expressed in pounds per square inch of cross section. This property has an absolute value in some applications where the product is actually subjected to tension in service but, like the other tension properties, it is most frequently used in evaluating compounding materials on a cooperative basis.

In a series of cures with a variable time factor the tensile strength either passes through a maximum or exhibits a marked change in the slope of its curve. Therefore, the tensile strength may be considered either separately or together with the modulus and elongation in defining an optimum state of cure for any specific compound.



all references to competitors' part numbers are for cross reference purposes only



5/16" STANDARD RUBBER MUD FLAPS

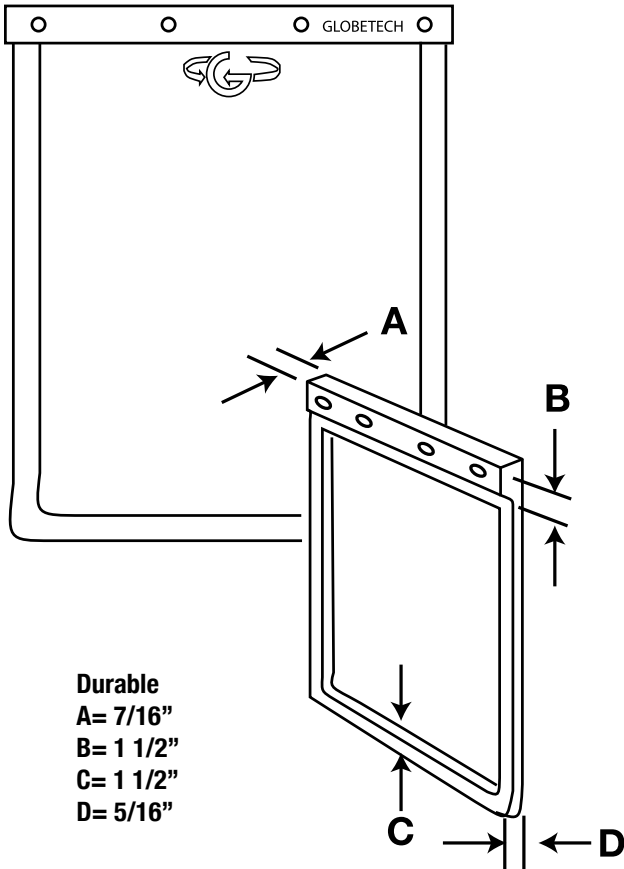

Globetech's Standard Mud Flaps

Globetech uses the finest material available to mold its standard mud flaps. These are the most popular mudflaps for logo use.

This material also meets all MIL-SPEC for Military Contractors.



Mud Flaps & Accessories

Our 5/16" Standard splash guards are slightly heavier than our Chevron flaps. The majority of our customers prefer the Standard flap for their Custom logos.

Part Number	Description	Weight Per Pair
GT-1218S	12x18 Standard Rubber Mud Flap	4 lbs.
GT-1924S	19x24 Standard Rubber Mud Flap	5 lbs.
GT-2015S	20x15 Standard Rubber Mud Flap	7 lbs.
GT-2414S	24x14 Standard Rubber Mud Flap	11 lbs.
GT-2418S	24x18 Standard Rubber Mud Flap	11 lbs.
GT-2424S	24x24 Standard Rubber Mud Flap	13lbs.
GT-2430S	24x30 Standard Rubber Mud Flap	15lbs.
GT-2436S	24x36 Standard Rubber Mud Flap	17lbs.

all references to competitors' part numbers are for cross reference purposes only



MUD FLAPS & ACCESSORIES

3/8" XTREME RUBBER MUD FLAPS



← Nylon Mesh Reinforcement

Part Number	Description	Weight Per Pair
GT-2424XD	24x24 3/8" XTREME Mud Flap	16 lbs.
GT-2430XD	24x30 3/8" XTREME Mud Flap	17 lbs.
GT-2436XD	24x36 3/8" XTREME Mud Flap	19 lbs.
GT-2440XD	24x40 3/8" XTREME Mud Flap	21lbs.
GT-2442XD	24x42 3/8" XTREME Mud Flap	24lbs.

★ XTREME ★

Correlation of Constrained Path Tear versus Off Road Tire Performance

The chart below illustrates the degree of correlation between CP tear strength at 100°C and the cuttingchipping rating of a series of compounds in an off-road tire performance test.

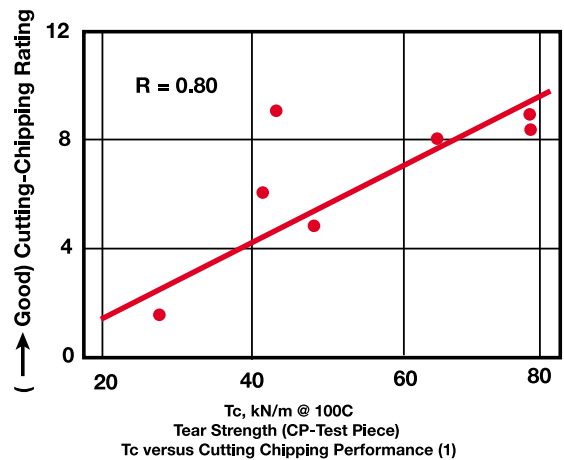

XTREME MUD FLAP

- Our Xtreme Mud Flap is molded from high tensile strength rubber. Using conveyor belt technology, a wire of nylon sheet is molded into the mud flap for greater durability.
- Great for dump trucks and off-road use
- Highest tear strength of any mud flap
- Stiffer flap prevents waving
- Available with silk-screen or raised molded logo

ABSOLUTE TOUGHEST FLAP ON THE MARKET!
REPLACES: STA-PUT-FLAPS

all references to competitors' part numbers are for cross reference purposes only



1/2" HEAVY DUTY ANTI-SPRAY MUD FLAPS



The **Heavy-Duty, Anti-Spray Flap** is the ultimate flap. The 1/2" thick reinforced rubber gives the flap anti-sail features. Raised knobs on the back side for anti-spray.

Part Number	Description	Weight Per Pair	Replaces Koneta
GT-2424HDD	24x24 1/2" Heavy Duty USA Mud Flap	19 lbs.	082424
GT-2430HDD	24x30 1/2" Heavy Duty USA Mud Flap	22 lbs.	082430
GT-2436HDD	24x36 1/2" Heavy Duty USA Mud Flap	24 lbs.	082436

- 45 Degree angle mount capable
- 30/36 dual mount capable
- Hole at bottom of flap for hook up
- Available with silk-screen or raised molded logo

Mud Flaps & Accessories

QUICK CHANGE, AS ANTI-SPRAY MUD FLAPS



Part Number	Description	Weight Per Pair	Replaces Koneta
GT-2424AS	24x24 Quick Change Anti-Spray Mud Flap	18 lbs.	84500
GT-2430AS	24x30 Quick Change Anti-Spray Mud Flap	24 lbs.	84502
GT-2436AS	24x36 Quick Change Anti-Spray Mud Flap	30 lbs.	84504

ALL-RUBBER ANTI SPRAY QUICK CHANGE MUD FLAPS

Save time and money with two-step Quick Change Mud Flaps!

The Quick Change Anti-Spray mud flap features the easy two-step quick changeability plus finger-like projections directing spray downward while the built-in side ridges prevent lateral spray.

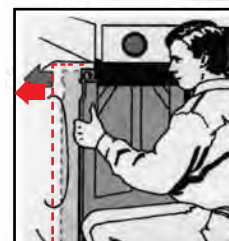

Step 1. Slip out the old mudflap

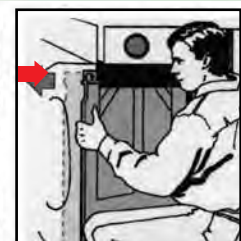

Step 1. Slip in the new mudflap

all references to competitors' part numbers are for cross reference purposes only



MUD FLAPS & ACCESSORIES

ANTI-SAIL QUICK MOUNT MUD FLAPS



Two embedded, all-steel bars resist wind force, even at high speeds. The convenience of quick maintenance combined with the stability of steel reinforcement bars.



Part Number	Description	Weight Per Pair	Replaces Koneta
GT-2430M	24x30 3/8" Quick Mount Mud Flap	20 lbs.	82506
GT-2436M	24x36 3/8" Quick Mount Mud Flap	22 lbs.	82504

Mud Flaps & Accessories

RAINTRAPPER RUBBER MUD FLAPS



The Raintrapper flap is manufactured in the U.S.A. by Globetech Manufacturing. This is the ultimate anti-spray mud flap for the heavy duty trucking industry. The Raintrapper mud flap features the finger-like projections directing spray downward while the built-in side ridges prevent lateral spray.

Part Number	Description	Weight Per Pair	Replaces Koneta No.
GT-2430RT	24x30 Raintrapper Flap	20 lbs.	84502

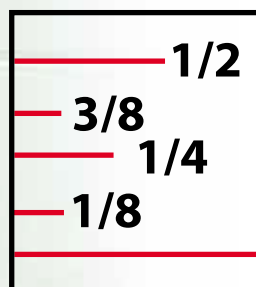
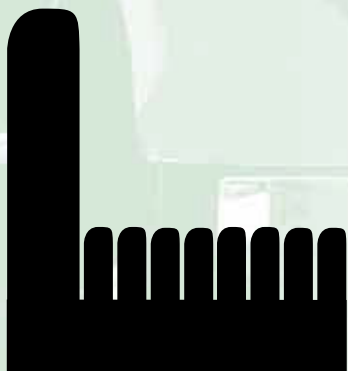

Profile diagram showing finger-like projections

all references to competitors' part numbers are for cross reference purposes only



SPECIALTY RUBBER MUD FLAPS



MIDGUARD MUD FLAPS

MidGuard Mud Flaps provide unsurpassed protection from flying gravel, splash and road spray. Available in three thicknesses.

Part Number	Description	Replaces
GT-443638	3/8" x 44" x 36"	140002
GT-4224XD	3/8" x 42" x 24"	n/a

A MUST HAVE FOR DUMP TRUCKS!

SIDE SHIELDS

- Side Shields offer ribbed construction to reduce spray from sides of trailers.

Part Number	Description	Replaces
GT-848S	Side Skirt Fap, 8" x 48" Rubber	074807



COLORED POLY FLAPS ALSO AVAILABLE - 24" X 30" X 3/16" ONLY
AVAILABLE COLORS: BLACK, WHITE, YELLOW

****Other sizes and thicknesses may also be available****



MUD FLAPS & ACCESSORIES

TIREPLAST MUD FLAPS

This recycled rubber is a combination of recycled rubber (from tires) and plastic, tireplast is environmentally friendly and allows for custom product specifications. A great replacement for most natural and synthetic rubber, tireplast has low temperature impact toughness, tensile strength, flexibility, and sound deadening capabilities. Tireplast is resistant to many chemicals including alcohol, anti-freeze, diesel fuel, gasoline, grease, hydraulic oil, kerosene, motor oil, distilled water, and salt water.

Finished Products

- Mats & Runners
- Drainage Mats
- Automotive Splash Guards
- Pick-up Truck Bed Liners
- Brake Pedal Pads
- Counter Top Mats
- Trailer Wall Liner
- Sound Deadening
- Agricultural Mats

TIREPLAST/THERMO PLASTIC MUD FLAPS



- Thermo plastic rubber
- Anti-curling attributes of a rubber flap
- Stiff anti-sail features of a poly flap
- Ribbed back for anti spray
- Also available in angle cut or rounded corners, Call our sales department for more information. Tireplast Mud Flap Profile



Part Number	Description	Thickness
2424TPPSB	Tireplast Mud Flap - Black 24"x24"	1/4"
2430TPPSB	Tireplast Mud Flap - Black 24"x30"	1/4"
2436TPPSB	Tireplast Mud Flap - Black 24"x36"	1/4"
2424TPHDB	Heavy Duty Tireplast Mud Flap - Black 24"x24"	3/8"
2430TPHDB	Heavt Duty Tireplast Mud Flap - Black 24"x 30"	3/8"
2436TPHDB	Heavy Duty Tireplast Mud Flap - Black 24" x 36"	3/8"

all references to competitors' part numbers are for cross reference purposes only



3/16" POLYGUARD STANDARD

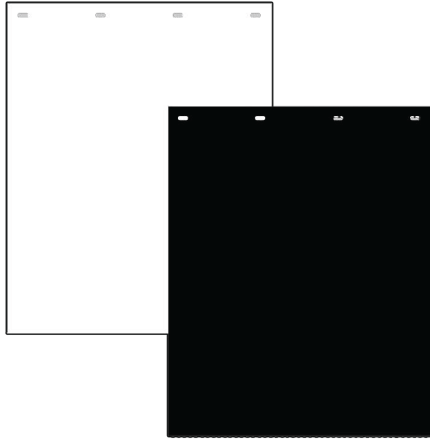

Part Number	Description	Weight Per Pair
2424PSB	24X24 Standard Poly - Black	
2424PSW	24X24 Standard Poly - White	6 lbs.
2430PSB	24x30 Standard Poly - Black	
2430PSW	24x30 Standard Poly - White	8 lbs.
2436PSB	24x36 Standard Poly - Black	
2436PSW	24x36 Standard Poly - White	10lbs.

Poly Standard Profile - Smooth Back

- 3/16" Thick
- Will not crack or curl
- Economic Price

1/4" ANTI-SPRAY POLY PLUS

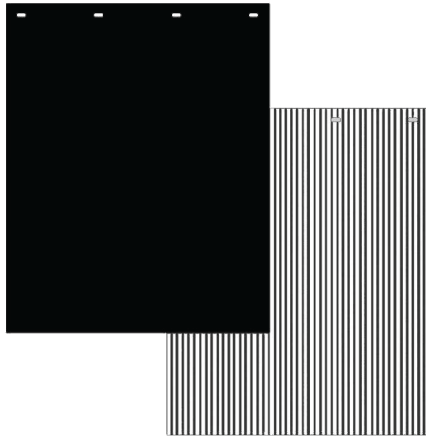

Part Number	Description	Weight Per Pair
2424PPSB	24X24 1/4" Anti-Spray - Black	
2424PPSW	24X24 1/4" Anti-Spray - White	7 lbs.
2430PPSB	24x30 1/4" Anti-Spray - Black	
2430PPSW	24x30 1/4" Anti-Spray - White	9 lbs.
2436PPSB	24x36 1/4" Anti-Spray - Black	
2436PPSW	24x36 1/4" Anti-Spray - White	11lbs.

Poly Plus Profile - Anti-Spray Back

- 1/4" Thick
- Anti-Spray Ribbed Back
- Medium Duty

3/8" ANTI-SPRAY POLY PLUS HD

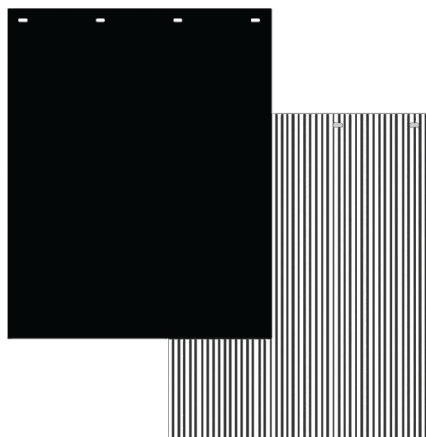

Part Number	Description	Weight Per Pair
2424PHDB	24X24 3/8" Anti-Spray - Black	
2424PHDW	24X24 3/8" Anti-Spray - White	10 lbs.
2430PHDB	24x30 3/8" Anti-Spray - Black	
2430PHDW	24x30 3/8" Anti-Spray - White	12 lbs.
2436PHDB	24x36 3/8" Anti-Spray - Black	
2436PHDW	24x36 3/8" Anti-Spray - White	14 lbs.

Poly HD Profile - Anti-Spray Back

- 3/8" Thick
- Anti-Spray Ribbed Back
- Heavy Duty

all references to competitors' part numbers are for cross reference purposes only



MUD FLAPS & ACCESSORIES



SILK-SCREEN LOGO RUBBER MUD FLAPS

SILK-SCREEN LOGOS OFFER:

- Multi-Color logos with great detail!
- Long lasting urethane paint also used on floors and running tracks **WILL NOT WEAR OFF**
- Fast turn around

Mud Flaps & Accessories

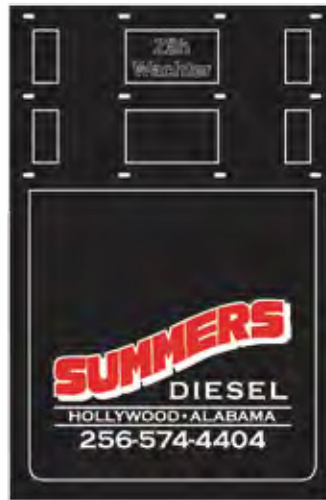

all references to competitors' part numbers are for cross reference purposes only



POLYGUARD CUSTOM LOGO MUD FLAPS

Antispray Poly Mud Flaps Material Specification Sheet:

Property Material

- Tensile Strength
- Tensile Elongation
- Specific Gravity
- Hardness, Shore D
- Tear Resistance
- Flexural Modulus
- Notched Low Temperature Brittleness

ASTM Test Method Polyethylene	Value Polyethylene
D638	>4000 psi
D638	>1000%
D792	0.925
D2240	51
D1004	>1000 psi
D790	150,000 psi
D746	-42 C



HOT STAMPED LOGOS

all references to competitors' part numbers are for cross reference purposes only



MUD FLAPS & ACCESSORIES

RAISED MOLDED CUSTOM LOGO MUD FLAPS

Standard 5/16" Rubber Raised Molded

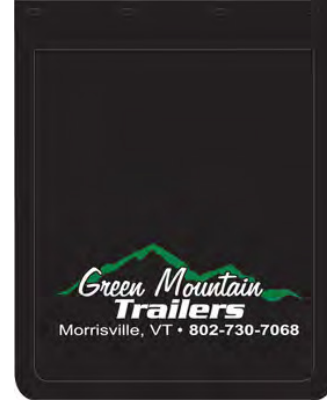

Part Number	Description	Weight Per Pair
GT-1220RSM	12" x 20" Standard 5/16" Rubber Raised Molded Custom Logo	6 lbs.
GT-1924RSM	19" x 24" Standard 5/16" Rubber Raised Molded Custom Logo	11 lbs.
GT-2414RSM	24" x 14" Standard 5/16" Rubber Raised Molded Custom Logo	1 lbs.
GT-2418RSM	24" x 18" Standard 5/16" Rubber Raised Molded Custom Logo	11 lbs.
GT-2424RSM	24" x 24" Standard 5/16" Rubber Raised Molded Custom Logo	13 lbs.
GT-2430RSM	24" x 30" Standard 5/16" Rubber Raised Molded Custom Logo	15 lbs.
GT-2436RSM	24" x 36" Standard 5/16" Rubber Raised Molded Custom Logo	17 lbs.



Heavy Duty 1/2" Rubber Raised Molded with Anti-Spray

Part Number	Description	Weight Per Pair
GT-2424HDRM	24" x 24" Heavy Duty 1/2" Rubber Raised Molded Custom Logo with Anti-Spray	19 lbs.
GT-2430HDRM	24" x 30" Heavy Duty 1/2" Rubber Raised Molded Custom Logo with Anti-Spray	22 lbs.
GT-2436HDRM	24" x 36" Heavy Duty 1/2" Rubber Raised Molded Custom Logo with Anti-Spray	24 lbs.
GT-2442HDRM	24" x 42" Heavy Duty 1/2" Rubber Raised Molded Custom Logo with Anti-Spray	26 lbs.

all references to competitors' part numbers are for cross reference purposes only

MUD FLAPS & ACCESSORIES



RAISED MOLDED CUSTOM LOGO MUD FLAPS



Rain Guard 3/8" Multi-Header Raised Molded with Anti-Spray

- Multi-Header Perfect for dump trucks, and off-road applications
- Anti-Spray
- Anti-Sail
- Hole to Pin Flap Up to Avoid Tearing



Mud Flaps & Accessories

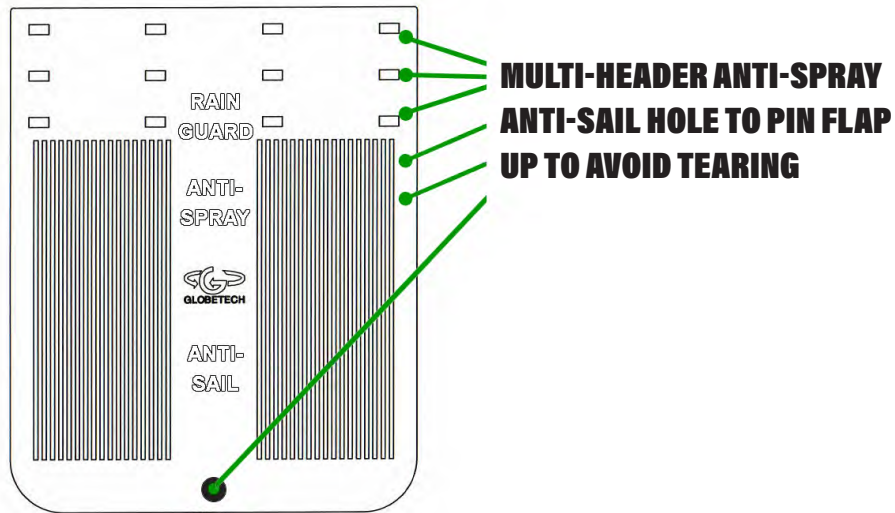

Part Number	Description	Weight Per Pair
GT-2424RGM	24" x 24" RainGuard 3/8" Rubber Raised Molded Custom Logo with Anti-Spray	14 lbs.
GT-2430RGM	24" x 30" RainGuard 3/8" Rubber Raised Molded Custom Logo with Anti-Spray	15 lbs.
GT-2436RGM	24" x 36" RainGuard 3/8" Rubber Raised Molded Custom Logo with Anti-Spray	16 lbs.

All raised molded flaps are made in Dayton, Ohio USA.











Our Flaps are made from 100% friction reinforced material to ensure ultimate tear strength and durability.

all references to competitors' part numbers are for cross reference purposes only

CUSTOM LOGO COLOR MUD FLAPS

NOTE: Standard black and white available for all logo types.

Silkscreen for rubber flaps	
	Red - Pantone 185 C
	Blue - Pantone 2945 C
	Yellow - Pantone 115 C
	Green - Pantone 3298 C
	Orange - Pantone 1655 C
	Gray - P Cool Gray 5 C

Hot Stamp for poly flaps			
Red  P 186 C	Blue  P 2935 C	Dark Blue  P 2965 C	Light Blue  P 2925 C
Dark Green  P 3435 C	Yellow  P 116 C	Orange  P 172 C	Maroon  P 188 C
Green  P 348 C	Brown  P 1615 C	Gray  P Cool Gray 10 C	Custom colors available \$100 charge per color (silkscreen & hotstamp)

GUIDELINES

RUBBER with SILKSCREEN LOGO

- Minimum order 50 each (25 pair)
- Lead time: New Logos 6-8 weeks
- Lead time: Existing logos 4-6 weeks
- Additional charge for multi-color

RUBBER with RAISED MOLDED LOGO

- Minimum order 300 each (150 pair)
- Lead time: 12-15 weeks

POLY with HOT STAMP LOGO

- Minimum order 100 each (50 pair)
- Lead time: New Logos 6-8 weeks
- Lead time: Existing logos 4-6 weeks
- Additional charge for multi-color

- \$300 SET-UP CHARGE 1 color only
- Additional charge for multi-color

Ordering - Call 937-274-5587 or Email PO to logos@gtmfginc.com with the following info:

- Type of flaps: Rubber, Poly, or Tireplast
- Flap Size and Flap Thickness
- Order Quantity
- Flap Color
- Imprint (Logo) Color(s)

Artwork - Original Adobe Illustrator (vector artwork) files preferred

***we can also use high resolution .jpg, .eps, .ai, .pdf, or .png or mailed in sample flap**

all references to competitors' part numbers are for cross reference purposes only



2700 Needmore Rd. Ph: 937.274.5587
Dayton, OH 45401 Fax: 937.274.6102

MUDFLAP PROOF

Special Notes:

Customer: _____

Attn: _____

Flap Style: _____

Print Style: Hot Stamp Silkscreen

Flap Size: _____

Imprint
Color: _____

Order Qty: _____

Set-up Fee: _____

Approved By:
Signature: _____

Printed Name: _____ Date: _____

• Signed proof **MUST** be returned before production can begin!



MUD FLAPS & ACCESSORIES



STOCK RAISED MOLDED RUBBER MUD FLAPS

Mud Flaps & Accessories



Part Number	Description
20x14WYO	20x14 Big Wonderful Wyoming Raised Molded Logo
24x30WYO	24x30 Big Wonderful Wyoming Raised Molded Logo
24x36WYO	24x36 Big Wonderful Wyoming Raised Molded Logo



Part Number	Description
12X18BIGSKY	12x18 Big Sky Montana Raised Molded Logo
20x14BIGSKY	20x14 Big Sky Montana Raised Molded Logo
24x14BIGSKY	24x14 Big Sky Montana Raised Molded Logo
24x30BIGSKY	24x30 Big Sky Montana Raised Molded Logo
24x36BIGSKY	24x36 Big Sky Montana Raised Molded Logo

all references to competitors' part numbers are for cross reference purposes only



STOCK LOGO MUD FLAPS



GT-9026

GT-9021

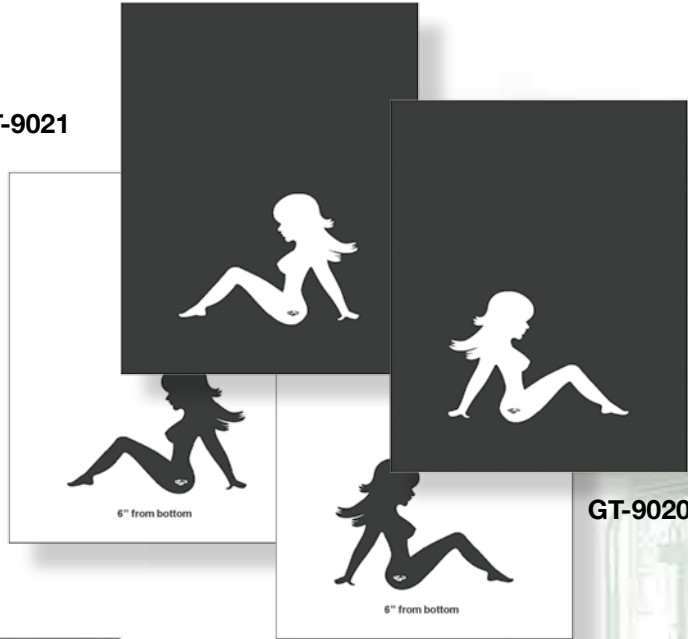

GT-9020



GT-9014 = White Poly
GT-9015 = Black Poly
GT-9016 = Yellow Poly



GT-9017



GT-9032



GT-9019



GT-9023



GT-9024 - Black
GT-9025 - White

Mud Flaps & Accessories

all references to competitors' part numbers are for cross reference purposes only



MUD FLAPS & ACCESSORIES

OHSA SPECIFIES:

1910.178(K) TRUCKS AND RAILROAD CARS

(1) The brakes of highway trucks shall be set and wheel chocks placed under the rear wheels to prevent the trucks from rolling while they are boarded with powered industrial trucks.



GT-2047D - Domestic HD Chock



- Large zinc-plated eyebolt
- Non-skid bottom
- 8"D x 10"L x 6"H

Replaces: Koneta 430030

GT-2048D - Domestic HD Chock



- Most popular design
- Zinc-plated eyebolt
- 9lbs.
- 8"D X 9-1/2"L X 5-3/4"H

GT-2049 - Contour Chock



- Molded handle on the back
- Nylon safety rope on request
- 11 pounds
- Used for heavy equipment and trucks

Replaces: Koneta 430030

GT-2050 - Standard Utility Chock



- Cored out back
- Power-coated handle
- 8 pounds
- Used by utility companies
- 8"D x 10"L x 5"H

GT-2052D - Recessed Stair Step Wheel Chock



- Recessed Zinc plated eyebolt
- Sharp steps to grip better
- 9 pounds
- 8"D x 9"L x 6"H

GT-2057 - Large Chock



- 16 pounds
- 10"D x 12"L x 8"H
- Used for off-road equipment and trucks

A52475 - Chock with Chain



GT-2047D wheel chock with chain assembly can be sold separate or attached to wheel chock.

all references to competitors' part numbers are for cross reference purposes only

NEW PART



Shark Skin TRAILER BUMPERS



Globetech's 4-Layer Protection

- 2-Layers of abrasion resistant, high-tear strength compound
- 2-Layers of Styrene Butadiene encapsulated nylon cord sheets
- Base rubber compound consists of fiber reinforced prime rubber containing nylon and polyester
- Resists aging from weather, ozone, heat, abrasion and chemicals.

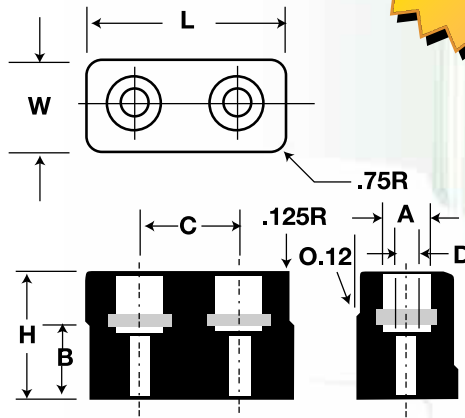

Part Number	A	B	C	D	L	W	H
GT-2000	1-1/2"	3-1/2"	3"	9/16"	6"	3"	5"
GT-2006	1-1/2"	1-3/4"	3"	9/16"	6"	3"	3-1/2"
GT-2312	1-3/8"	1-1/8"	2-5/8"	17/32"	6"	2-3/8"	3-1/4"
GT-2027	1-3/16"	1-3/4"	3-1/2"	11/16"	5-3/4"	3-3/4"	4-1/2"
GT-2042	1-1/4"	1"	4-5/8"	9/16"	7-7/8"	2-3/8"	2"
GT-2044	1-1/2"	1-1/4"	2-5/8"	17/32"	6"	2-3/4"	3"
GT-2345	1-7/16"	1-1/4"	3-1/2"	5/8"	6"	2-5/8"	3-1/4"
GT-UTM053	1-1/4"	3-1/2"	3-1/2"	17/32"	6-1/8"	3-5/8"	5-1/4"
GT-UTM172	1-1/4"	2-3/4"	3-1/2"	17/32"	6-1/8"	3-5/8"	4-1/2"
GT-UTM214	1-1/4"	1-3/4"	2-3/8"	1-7/32"	4-5/8"	2-5/8"	3-1/2"
GT-UTM259	1-1/4"	2-1/4"	3-1/2"	17/32"	6-1/8"	3-5/8"	4"
GT-UTM006	1-1/4"	1-3/4"	3-1/2"	17/32"	6-1/8"	3-5/8"	3-1/2"

Material Specifications

- 80+5 Durometer
- Impact recovery (ASTM 1170) of 95%
- Tensile Strength 2000+ psi

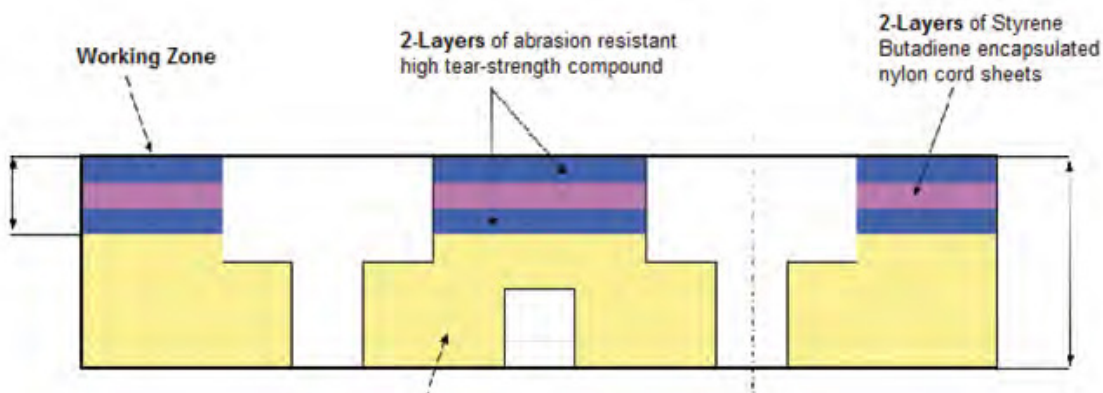

all references to competitors' part numbers are for cross reference purposes only



MUD FLAPS & ACCESSORIES



Shark Skin TRAILER BUMPERS

Globetech Manufacturing molded dock bumpers are the best in the industry. All bumpers are molded from fiber-reinforced rubber to ensure durability.

APPLICATIONS:

- Perfect protection for any high-traffic truck dock.
- In-plant wall protection from forklifts and other material-handling vehicles.

MATERIALS

- Manufactured from fiber-reinforced prime rubber containing nylon and polyester.
- All bumpers have an impact recovery (ASTM 1170) of 95% with 80+ 5 durometer tensile strength.
- All molds have pre-drilled, countersunk mounting holes for easy installation and are drilled to accept 3/4" anchor bolts.

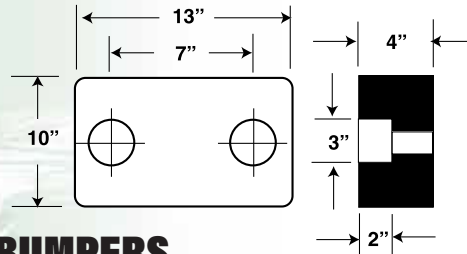
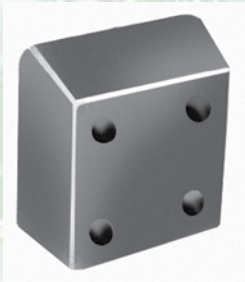

Part Number	Description	Weight
GT-2099	DISCONTINUED	21LBS.

EXTRUDED RUBBER BUMPERS

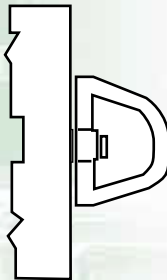

Extruded Rubber Bumpers

- Available up to 10 ft.
- For Live Stock Trailers
- Drilled holes

Part Number	Description	Weight
D-312	D-3 Dock Bumper 12" L x 3" W x 3" H	3 lbs.
D-324	D-3 Dock Bumper 24" L x 3" W x 3" H	6 lbs.
D-372	D-3 Dock Bumper 72" L x 3" W x 3" H	18 lbs.
D-412	D-4 Dock Bumper 12" L x 4" W x 4" H	6 lbs.
D-412A	D-4 Dock Bumper No Holes 24" L x 4" W x 4" H	6 lbs.
D-424	D-3 Dock Bumper 24" L x 4" W x 4" H	10lbs.
D-424A	D-4 Dock Bumper No Holes 24" L x 4" W x 4" H	10 lbs.
D-472	D-4 Dock Bumper 72" L x 4" W x 4" H	36 lbs.
D-612	D-6 Dock Bumper 12" L x 4" W x 6" H	9 lbs.
D-624	D-6 Dock Bumper 24" L x 4" W x 6" H	18lbs.
D-672	D-6 Dock Bumper 72" L x 4" W x 6" H	36lbs.

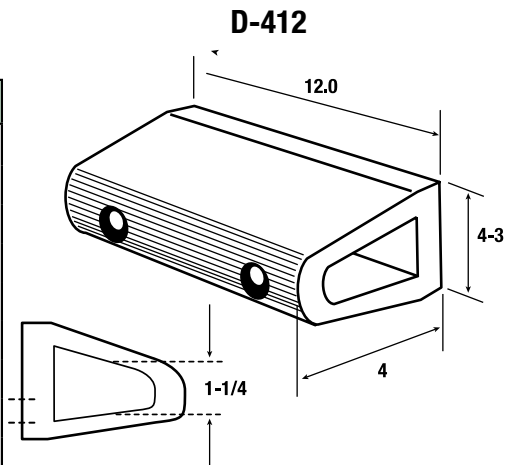

all references to competitors' part numbers are for cross reference purposes only



Shark Skin TRAILER BUMPERS



STANDARD MATERIAL

- Manufactured from fiber-reinforced prime rubber containing nylon & polyester
- 80+5 Durometer
- Impact recovery (ASTM 1170) of 95%
- Tensile strength = 2000+ psi
- Compression molded Part Number

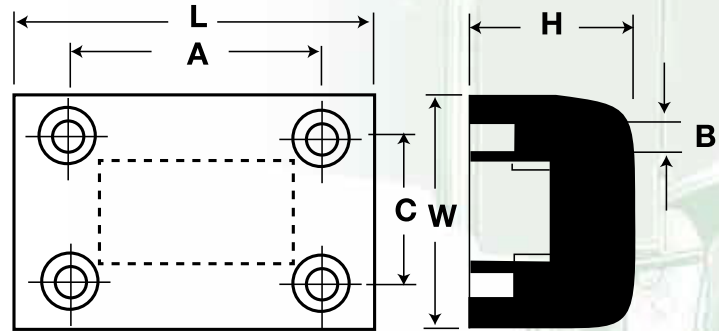

Part Number	A	B	C	L	W	H
GT-2036	5-1/2"	3/4"	3-1/4"	8"	5-1/4"	3-5/8"
GT-2045	5-1/2"	9/16"	3"	7=5/8"	5-1/2"	3-5/8"
GT-2046	5-3/8"	9/16"	3-1/8"	8"	6"	3"

SPECIAL BUMPERS

Globetech can manufacture any custom molded bumper top any specification.

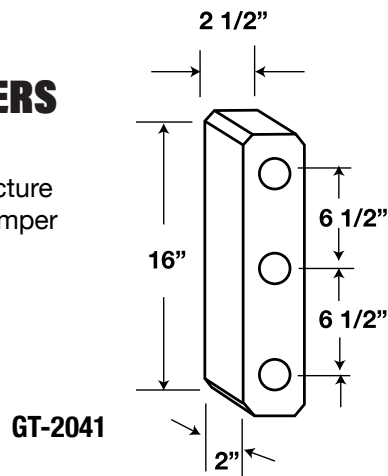

Part Number	Approx. Weight Each	Size
GT-2041	3 lbs.	2" x 2" x 16"

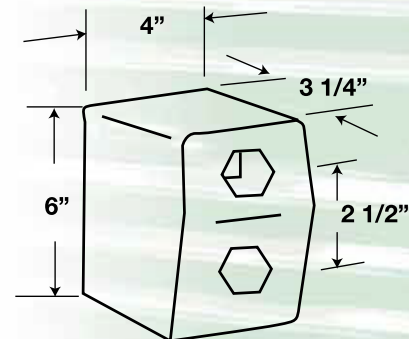

Part Number	Approx. Weight Each	Size
GT-2043	3 lbs.	6" x 4" x 3"

all references to competitors' part numbers are for cross reference purposes only



MUD FLAPS & ACCESSORIES

LAMINATED BUMPERS

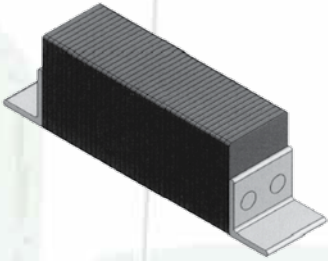

Bolt-On **GT-2100** =
WAB21400170 **GT-2105**
= WAB21400177

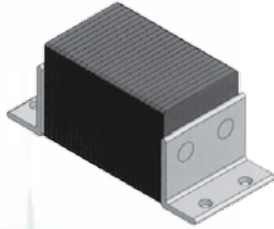

Bolt-On
GT-2101

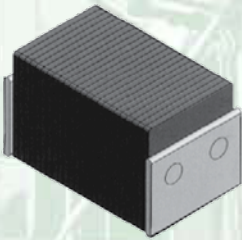

Weld-On
GT-2102

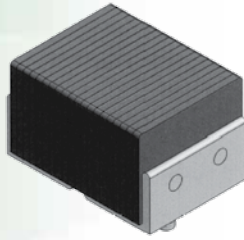

Weld-On
GT-2103

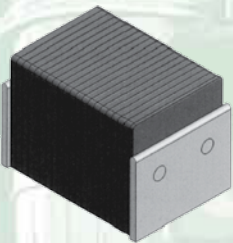

Weld-On
GT-2104

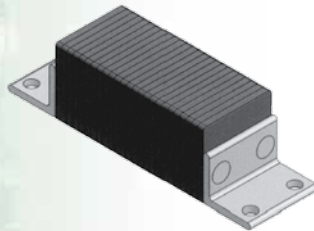

Weld-On
GT-2106

- Stainless steel hardware
- Multi-ply belting
- Custom bumpers available

Part Number	Length	Width	Height
GT-2100	10-1/4"	3"	3-1/2"
GT-2101	6"	4"	4"
GT-2102	5-1/2"	4"	3"
GT-2103	5-1/2"	4"	3-1/4"
GT-2104	5-5/8"	4"	4"
GT-2105	9-1/2"	3"	4"
GT-2106	6-1/4"	2-7/8"	2-3/4"
GT-2107	6-1/8"	3-1/4"	2-3/4"
GT-2109	6"	2-3/4"	3"

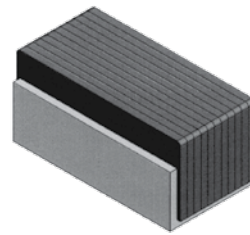

Stud Mount
GT-2107

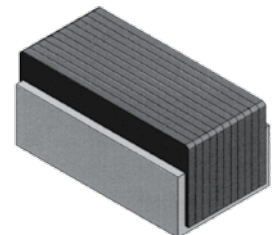

Stud Mount
GT-2109

DOOR BUMPERS

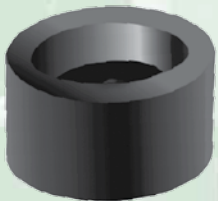

GT-025



GT-2108

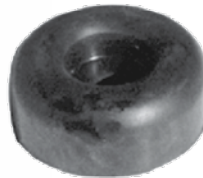

GT-2613

- Made of SBR 60 Durometer

Part Number	Size	Hole Diameter
GT-025	1-7/8" x 1-5/8"	9/16"
GT-2108	1-1/2" x 3/4"	1/4"
GT-2613	2-1/2" x 1"	3/8"

all references to competitors' part numbers are for cross reference purposes only



STANDARD .640 BAR TYPE MUD FLAP HANGERS

The .640 square spring steel hangers are the standard for the trucking industry. Globetech mud flap hangers are manufactured and tested to OEM specs using SAE test methods. Our hangers are made to accommodate flaps of all sizes.

Kits include (2) mud flap hangers with adjustable flap clips, (2) GT-27B711 mounting brackets, (2) cotter pins and mounting hardware for flaps and brackets.

Part Number	Description	Cross Ref.	
GT-2723B	Kit w/hardware, pair	B23	031-00123



Part Number	Description	Cross Ref.	
GT-2725A	Standard Straight Hanger 10/Box *hardware not included	A25	034-00426
GT-2725B	Kit w/ hardware, pair	B25	031-00125
GT-2725B70	Bulk Barrel 70/ea *hardware not included	A25RLB40	031-0050

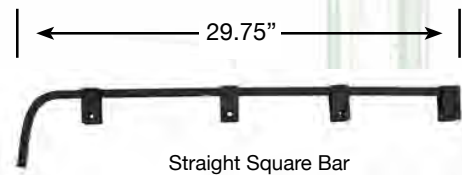

Part Number	Description	Cross Ref.	
GT-2733B	Kit w/hardware, pair	B33	031-00133



Part Number	Description	Cross Ref.	
GT-2735A	Standard Angled Hanger 10/Box *hardware not included	A35	034-00433
GT-2735B	Kit w/hardware, pair	B35	031-00135
GT-2735B40	Bulk Barrel 40/ea, *hardware not included	A35RLB40	031-00049



Part Number	Description	Cross Ref.	
GT-2729B	Kit w/hardware, pair	B29	031-00129

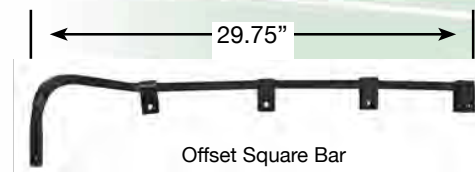

all references to competitors' part numbers are for cross reference purposes only



MUD FLAPS & ACCESSORIES

Globetech mudflap hangers and brackets are manufactured to the highest specifications to meet your needs.

Our mudflap hangers were tested by an independent lab and resulted in a superior rating for minimum permanent deflection.

Globetech mudflaps surpassed the Rockwell Hardness B testing per ASTM E18.



HEAVY DUTY .750 BAR TYPE MUD FLAP HANGER

The .750 square spring steel hangers are among the strongest and most durable flap hangers on the market, designed to meet heavy load of antispray flaps. Globetech mud flap hangers are manufactured and tested to OEM specs using SAE test methods.

Kits include (2) mud flap hangers with adjustable flap clips, (2) GT-27B700 mounting brackets, (2) cotter pins and mounting hardware for flaps and brackets.

Part Number	Description	Cross Ref.
GT-2721B	Kit w/hardware, pair	B21 031-00121

Part Number	Description	Cross Ref.
GT-2781A	HD angled hanger 10/Box *hardware not included	A81 034-00685
GT-2781B	Kit w/hardware, pair	B81 031-00105

Part Number	Description	Cross Ref.
GT-2782A	HD straight hanger 10/Box *hardware not included	A82 034-00679
GT-2782B	Kit w/hardware, pair	B82 031-00102

Part Number	Description	Cross Ref.
GT-2783B	Kit w/hardware, pair	B83 031-00108

Part Number	Description	Cross Ref.
GT-2784B	Kit w/hardware, pair	B84 031-00110

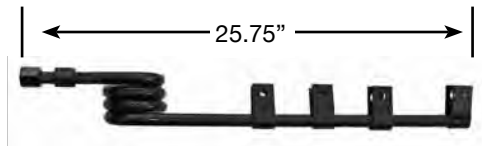

Straight HD Round Triple Coil

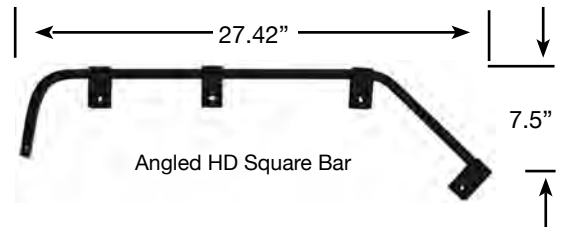

Angled HD Square Bar

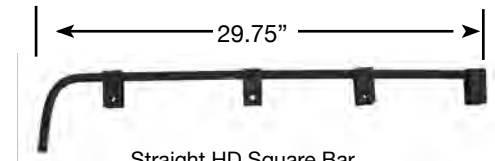

Straight HD Square Bar

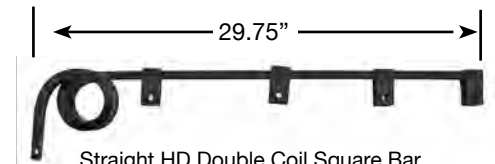

Straight HD Double Coil Square Bar

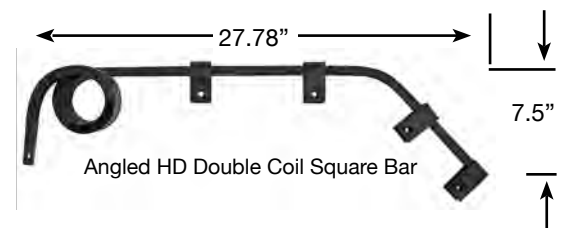

Angled HD Double Coil Square Bar

all references to competitors' part numbers are for cross reference purposes only



STANDARD MOUNTING BRACKETS FOR .640 HANGERS

- Cast steel construction
- Black primed finish
- Allows for relocation of brackets from one vehicle to another
- Kits include (2) brackets, (4) bolts w/lock washer, (4) nuts and (2) cotter pins

Part Number	Description	Cross Ref.
GT-27B711	Black cast mount bracket, single	B711
GT-27K711	Kit w/mounting hardware, pair	K711

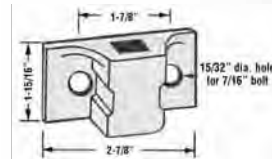

HEAVY DUTY MOUNTING BRACKETS FOR .750 HANGERS

- Cast steel construction
- Black primed finish
- Allows for relocation of brackets from one vehicle to another
- Kits include (2) brackets, (4) bolts w/lock washer, (4) nuts and (2) cotter pins

Part Number	Description	Cross Ref.
GT-27B700	Black HD cast mount bracket, single	B700
GT-27K700	Kit w/mounting hardware, pair	K700

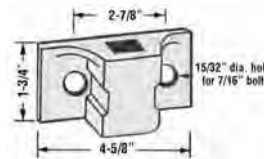

STANDARD ANTI-SAIL BRACKET

- Assembly required
- Part number represents single bracket only - enough for one mud flap
- Fits standard 24.00" flaps
- Will accommodate flaps up to 3/8" thick

Part Number	Description	Weight	Cross Ref.
GT-2701SS	21" x 24" Anti-Sail Bracket Stainless Steel	1.82	033-05126
GT-2701C	21" x 24" Anti-Sail Bracket Chrome	1.82	033-05126



STANDARD ANTI-SAIL BRACKET- ONE PIECE DESIGN

- Assembly required
- Part number represents single bracket only - enough for one mud flap
- Fits standard 24.00" flaps
- Will accommodate flap up to 1.00" thick

Part Number	Description	Weight	Cross Ref.
GT-2702SS	21" x 24" Anti-Sail Bracket One Piece Stainless Steel	1.82	033-00076
GT-2702C	21" x 24" Anti-Sail Bracket One Piece Chrome	1.82	033-00075



all references to competitors' part numbers are for cross reference purposes only



MUD FLAPS & ACCESSORIES

MUD FLAP MOUNTING ANGLE & RETAINING STRAP

- .12" thick, heavy-duty steel construction
- Black primer finish

Part Number	Description	Weight	Cross Ref.	
GT-27051	2.00 x 2.00 x 27.50 mounting angle	3.4 lbs.	#07-50	033-00051
GT-27053	2.00 x 24.00 retaining strap	1.4 lbs.	#07-50-1	033-00053



MUD FLAP BOLT KIT

- Attaches mud flaps to any type of mud flap bracket
- Sets consists of eight bolts, eight nuts, and sixteen washers
- Enough to hang two mud flaps
- Available in Stainless steel or Zinc options

Part Number	Description	Weight	Cross Ref.
GT-27516	Mud Flap Bolt Kit Stainless Steel packaged set	0.72	031-01200
GT-27517	Mud Flap Bolt Kit Zinc packaged set	0.72	031-01298



GT-2725A



GT-2735A

BULK DISPLAYS

Part Number	Description	Cross Ref.
GT-2725B40	Square Steel Straight Angle Hangers 70/ea-GT-2725A Bulk Barrel	A35RLB40
GT-2735B40	Square Steel Angled Down Hangers 40/ea-GT2735A Bulk Barrel	A35RLB40

DISCONTINUED

all references to competitors' part numbers are for cross reference purposes only

Mud Flaps & Accessories



CONSPICUITY STRIPS

- Durable Aluminum Plate
- Reflective tape meets FMVS standard
- Universal used either on roadside or curbside
- Can be used with any straight, shortie, bar or spring loaded bracket

DISCONTINUED

Part Number	Description	Cross Ref.
GT-27RT25	Straight Aluminum Conspicuity Strips, pair	RT25
GT-27RT35	Angled Aluminum Conspicuity Strips, pair	RT35

CONSPICUITY TAPE

- DOT-C2 certified, exceeds NHTSA requirements
- Highly reflective, even up to a 90° angle
- Available in red and white roll/strips, all white roll or all yellow roll
- Quick and easy to apply

Part Number	Description	Type
GT-27000	12" x 2" Strip (2)ea / 6" red x 6" white pattern	strip
GT-27003	150 feet / 6" red x 6" white pattern	roll
GT-27004	150 feet / 11" white x 7" red pattern	roll
GT-27005	150 feet all white tape	roll
GT-27006	150 feet all yellow tape	roll
GT-27007	150 feet all orange tape	roll



Mud Flaps & Accessories

PLASTIC REFLECTIVE END CAP

- For use on all GT-27 Economy Brackets and many other brands

DISCONTINUED

Part Number	Description	Cross Ref.
GT-27069	Plastic End Cap Packaged Set for GT-27 Economy Brackets	031-01269

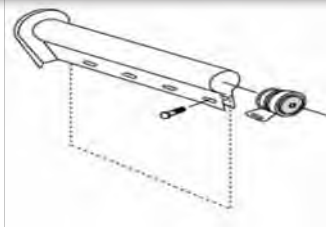



MUD FLAPS & ACCESSORIES

ECONOMY SPRING LOADED BRACKETS

Straight Tube Style Economy Bracket (replaces FB-27)

- Heavy-duty construction
- Design eliminates wind-caused bracket rotations
- Reduces flap and bracket damage
- Conforms to TTMA flap hole pattern
- Ideal for the heavy-duty spray suppression flaps



Part Number	Description	Bolt Pattern	Replaces Fleet Engineers
GT-27270	28" Straight Arm Economy (Black E-Coat)-set	1.12"	033-00270
GT-27277	28" Straight Arm Economy (Stainless Steel)-set	1.12"	033-00277
GT-27868	30" Straight Arm Economy (Black E-Coat)-set	1.12"	033-00868
GT-27870	30" Straight Arm Economy (Stainless Steel)-set	1.12"	033-00870



*Sets Include GT-27000

- 12" x 2" Strip
- (2) ea / 6" red x 6" white pattern

ANGLED DOWN TUBE STYLE BRACKET (replaces FB-27)

- Heavy-duty steel construction
- Design eliminates wind-caused bracket rotations
- Reduces flap and bracket damage
- Conforms to TTMA flap hole pattern
- Ideal for the heavy-duty spray suppression flaps



Part Number	Description	Bolt Pattern	Replaces Fleet Engineers
GT-27864	27" Angled Down Economy (Black E-Coat)-set	1.12"	033-00864
GT-27865	27" Angled Down Economy (Stainless Steel)-set	1.12"	033-00865
GT-27404	30" Angled Down Economy (Black E-Coat)-set	1.12"	033-03404
GT-27150	30" Angled Down Economy (Stainless Steel)-set	1.12"	033-04150



*Sets Include GT-27000

- 12" x 2" Strip
- (2) ea / 6" red x 6" white pattern

Mud Flaps & Accessories

all references to competitors' part numbers are for cross reference purposes only



HEAVY DUTY SPRING LOADED BRACKETS

Straight Arm HD Bracket (replaces Betts B57)

- Springs allow bracket to flex for extra durability
- Absorbs vibration, resists flap snags
- Springs allow bracket to flex for extra durability
- Works with any standard 24" wide flap
- Sets Includes two hangers w/reflective tape, and hardware



Part Number	Description	Bolt Pattern	Replaces Betts
GT-27B5728	28" Straight Arm HD (Black E-Coat) -set	1.18"	B5728
GT-27B5728SS	28" Straight Arm HD (Stainless Steel)-set	1.18"	B5728S
GT-27B57	30" Straight Arm HD (Black E-Coat)-set	1.18"	B57
GT-27B57SS	30" Straight Arm HD (Stainless Steel)-set	1.18"	B57S



*Sets Include GT-27000

- 12" x 2" Strip
- (2) ea / 6" red x 6" white pattern

ANGLED DOWN HD BRACKET

(replaces Betts B67 & B68)

- Downward angle allows for mounting in tight spaces
- Absorbs vibration, resists flap snags
- Springs allow bracket to flex for extra durability
- Works with any standard 24" wide flap
- Sets Includes two hangers w/reflective tape, and hardware



Part Number	Description	Bolt Pattern	Replaces Betts
GT-27B6728	28" Angled Down HD (Black E-Coat)-set	1.18"	B672825
GT-27B6728SS	28" Angled Down HD (Stainless Steel) -set	1.18"	B672825S
GT-27B6728C	28" Angled Down HD (Chrome)-set	1.18"	B672825C
GT-27B67	30" Angled Down HD (Black E-Coat)-set	1.18"	B67
GT-27B67SS	30" Angled Down HD (Stainless Steel) -set	1.18"	B67S
GT-27B67C	30" Angled Down HD (Chrome)-set	1.18"	B67C
GT-27B68	30" Angled Down HD (Black E-Coat)-set	2.5"	B68
GT-27B68SS	30" Angled Down HD (Stainless Steel)-set	2.5"	B68S
GT-27B68C	30" Angled Down HD (Chrome)-set	2.5"	B68C



*Sets Include GT-27000

- 12" x 2" Strip
- (2) ea / 6" red x 6" white pattern

all references to competitors' part numbers are for cross reference purposes only



MUD FLAPS & ACCESSORIES

HEAVY DUTY SPRING LOADED BRACKETS

Tapered Arm HD Bracket (replaces Betts B7 & B71)

- Springs allow bracket to flex for extra durability
- Tapered design is extremely strong & efficient
- Works with any standard 24" wide flap
- Conspicuity strip not included

Part Number	Description	Bolt Pattern	Replaces Betts
GT-27B71	30" Straight Arm HD Tapered(Black E-Coat)-set	1.18"	B71
GT-27B71SS	30" Straight Arm HD Tapered (Stainless Steel)-set	1.18"	B71S
GT-27B71C	30" Straight Arm HD Tapered (Chrome)-set	1.18"	B71C
GT-27B7	30" Straight Arm HD Tapered (Black E-Coat)-set	2.5"	B7
GT-27B7SS	30" Straight Arm HD Tapered (Stainless Steel)-set	2.5"	B7S
GT-27B7C	30" Straight Arm HD Tapered (Chrome)-set	2.5"	B7C



Mud Flaps & Accessories

HIGH VISIBILITY LIGHT BARS WITH 4" ROUND LIGHTS

- Stainless steel construction for durability
- Each stainless bar has 3 Pearl LED round lights
- Standard pigtailed included for easy installation
- Each bar measures 30" L x 6" W x 2.25" D
- Standard manufacturer's warranty included



Part Number	Description	Cross Ref.
GT-27LT77S	L.E.D. Kit w/hardware, pair	LT77S

VISIT US ONLINE AT GTMANUFACTURING.COM

USA MANUFACTURING

OEM QUALITY TRAILER PARTS



all references to competitors' part numbers are for cross reference purposes only



QUARTER FENDER MOUNTING INSTRUCTIONS

Recommended quarter fender mounting will result in maximum fender and top flap product life.

50-foot pounds of torque is needed on the steel clamp and 75-foot pounds of torque is needed on the stainless clamp. This torque is to be applied to the nut instead of the bolt. When this torque is applied, the flange end of the clamp should touch.

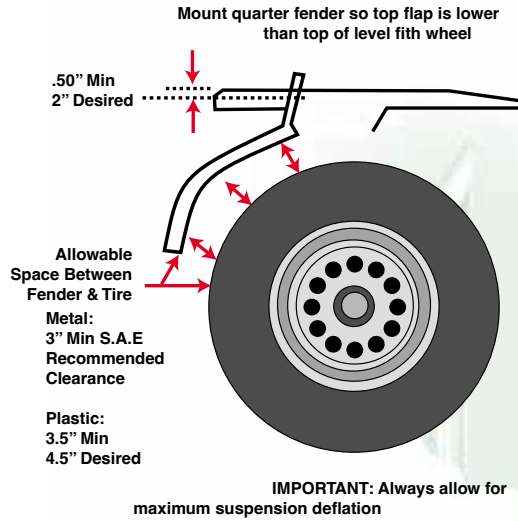

BRACELESS STANDARD QUARTER FENDER

- Durable 18 gauge formed metal
- Tube cradle support for added rigidity
- Mirror finish stainless steel
- Assembly required

Kit Includes:

- Two quarter fenders w/mounting hardware
- Two 24" rubber top flaps
- Top flap hardware
- Two clamps with 5/8" bolt and nut

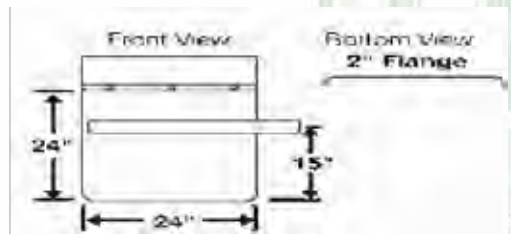

Part Number	Description	Replaces Fleetline	Weight
GT-39585B	Stainless Steel assembly, kit	1585B-Kit	29 lbs

FULL BRACE STANDARD QUARTER FENDER

- Durable 18 gauge formed metal
- Tube cradle support for added rigidity
- Mirror finish stainless steel
- Assembly required

Kit Includes:

- Two quarter fenders w/mounting hardware
- Two 24" rubber top flaps
- Top flap hardware
- Two clamps with 5/8" bolt and nut

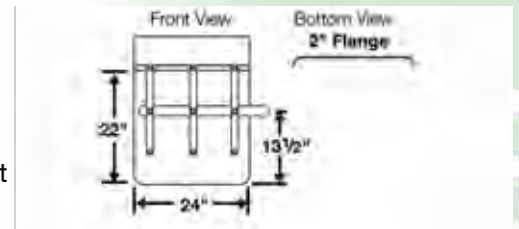

Part Number	Description	Replaces Fleetline	Weight
GT-39585FB	Stainless Steel assembly, kit	1585FB-Kit	32 lbs

all references to competitors' part numbers are for cross reference purposes only



MUD FLAPS & ACCESSORIES

HALF BRACE STANDARD QUARTER FENDER

- Durable 18 gauge formed metal
- Tube cradle support for added rigidity
- Assembly required
- Mirror finish stainless steel

- Kit Includes:
- Two quarter fenders w/mounting hardware
 - Two 24" rubber top flaps
 - Top flap hardware
 - Two clamps with 5/8" bolt and nut

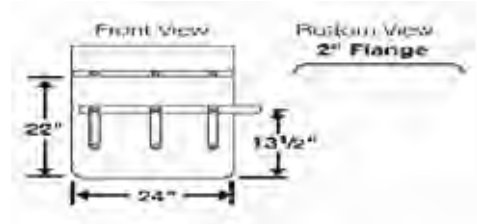

Part Number	Description	Replaces Fleetline	Weight
GT-39585HB	Stainless Steel assembly, kit	1585hB-Kit	30 lbs

LOW MOUNT STANDARD QUARTER FENDER

- Durable 18 gauge formed metal
- Tube cradle support for added rigidity
- Assembly required
- Mirror finish stainless steel

- Kit Includes:
- Two quarter fenders w/mounting hardware
 - Two 24" rubber top flaps
 - Top flap hardware
 - Two clamps with 5/8" bolt and nut

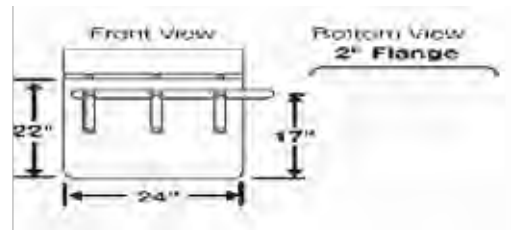

Part Number	Description	Replaces Fleetline	Weight
GT-39585LM	Stainless Steel assembly, kit	1585LM-Kit	29 lbs

BRACELESS POLY QUARTER FENDER

- Extreme Weather Polyethylene construction
- Guaranteed not to chip, crack or break
- Molded tube cradle for added rigidity
- Tested to -10°F without failure
- Assembly required

- Kit Includes:
- Two quarter fenders w/mounting hardware
 - Two 24" rubber top flaps
 - Top flap hardware
 - Two clamps with 5/8" bolt and nut

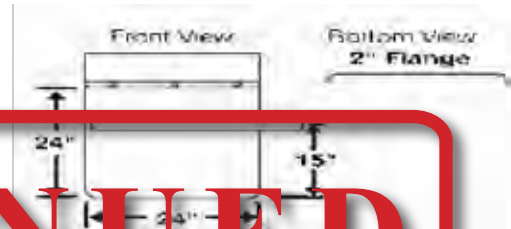

DISCONTINUED



Part Number	Description	Replaces Fleetline	Weight
GT-3900-L	Black Poly assembly, Left	1900-L	10 lbs
GT-3900-R	Black Poly assembly, Right	1900-R	10 lbs
GT-3900	Black Poly assembly, Pair	1900-KIT	20 lbs

all references to competitors' part numbers are for cross reference purposes only

Mud Flaps & Accessories



QUARTER FENDER TOP FLAPS

- Durable Black or White polyethylene and black rubber options
- Custom flaps available with company logo
- Top flap hardware not included

Part Number	Description	Weight
GT-2406	Black Rubber Plain, single	1.0 lbs.
2406PSB	Black Poly Plain, single	0.5 lbs.
2406PSW	White Poly Plain, single	0.5 lbs.



GT-2406

Part Number	Description	Weight
2605PSB	Black Poly Plain, single	0.5 lbs.
2605PSW	White Poly Plain, single	0.5 lbs.



TOP FLAP HARDWARE

- For use with plain or custom logo flaps
- Available in stainless or zinc plated steel and black nylon
- Includes eight nuts, eight bolts, and eight washers in a Globetech bag

Part Number	Description	Weight
GT-39414	Zinc Plated Steel Hardware, packaged set	0.3 lbs.
GT-39415	Staninless Steel Hardware, packaged set	0.3 lbs.
GT-39416	Black Nylon Hardware, packaged set	0.2 lbs.



all references to competitors' part numbers are for cross reference purposes only



MUD FLAPS & ACCESSORIES

QUARTER FENDER MOUNT TUBE

- Stainless Steel or Black E-Coat construction
- Must be used with post, side mount socket or 50" cross tube
- Includes 2" end cap
- Does not include clamp or hardware

Part Number	Description	Weight	Cross Ref.
GT-391625	27" Stainless steel pipe with end cap	2.5 lbs.	30 lbs
GT-391626	27" black E-Coat pipe with end cap	2.5 lbs.	30 lbs



QUARTER FENDER END CAPS

- Available in Stainless Steel or Black Plastic
- 2" Diameter

Part Number	Description	Weight	Cross Ref.
GT-391300	Stainless steel 2" end cap, (set)	.2 lbs.	1300-3A
GT-391301	black plastic 2" end cap, (set)	.2 lbs.	



*Sets packaged in Globetech bag



QUARTER FENDER CLAMPS

- Available in Stainless Steel or Black E-Coat
- Sets includes two clamps with 5/8" bolt/nuts

Part Number	Description	Weight	Cross Ref.
GT-391585	Stainless Steel 2" Fender Clamp w/ hardware (set)	.5 lbs.	1585-8WHA
GT-391590	Black E-Coat 2" Fender Clamp w/hardware (set)	.2 lbs.	1590-8WHA



all references to competitors' part numbers are for cross reference purposes only



POST MOUNT SOCKET

- Cast steel construction Black primer finish
- For independent post mounting
- Bolts directly to frame or suspension using present vehicle hardware
- 8.00" for added strength and durability



Part Number	Description	Weight	Cross Ref.
GT-391600	8" Stub Post Mount, single	3 lbs.	1600-15M



POST MOUNT SOCKET WITH FLANGE

- Steel construction Black E-Coat finish
- For independent side mounting
- Bolts directly to frame using present vehicle hardware
- Mounting plate 3.75" x 3.75"

Part Number	Description	Weight	Cross Ref.
GT-391601	8" Stub Post Mount with Flange, single	6 lbs.	1600-11M



CROSS-MOUNT TUBE KIT

- Steel construction Black primer finish
- For heavy-duty, over-the-frame mounting 50.00" long for added strength and durability
- Bulk kit contains one cross mount tube and all mounting hardware
- Hardware packaged set consists of mounting brackets, u-bolts, and nuts

Part Number	Description	Bar Length	Cross Ref.
GT-395000	50.00" Cross Mount Kit, including U-bolt Clamp Assembly	50.00"	555000

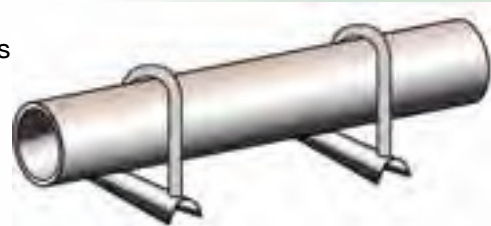

CROSS-MOUNT TUBE HARDWARE

- Two U-Bolts with brackets
- Four nuts
- Four washers

Part Number	Description	Weight	Cross Ref.
GT-395001	U-bolt Clamp Assembly Kit	1 lbs.	1580-12



all references to competitors' part numbers are for cross reference purposes only



QUICK REFERENCE GUIDE

STANDARD .640 BAR



GT-2723B



GT-2725B



GT-2733B



GT-2735B



GT-2729B

HEAVY DUTY .750 BAR



GT-2721B



GT-2781B



GT-2782B



GT-2783B



GT-2784B

SPRING LOADED



GT-27270



GT-27865



GT-27B6728



GT-27B57SS



GT-27B68



GT-27B7SS



GT-27LT77S



Mud Flaps & Accessories

Conspicuity Strips



GT-27RT25



GT-27RT35

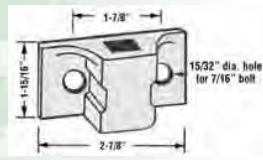

GT-27B711

Plastic Reflective End Cap



GT-27069

Anti-Sail Bracket

GT-2701SS



Hardware Kit



GT-27516



GT-39585B



GT-39585FB



GT-3900



GT-391600

Stub Mount



ABS CABLE

THE FAT CABLE

- More Copper
- More Tubing

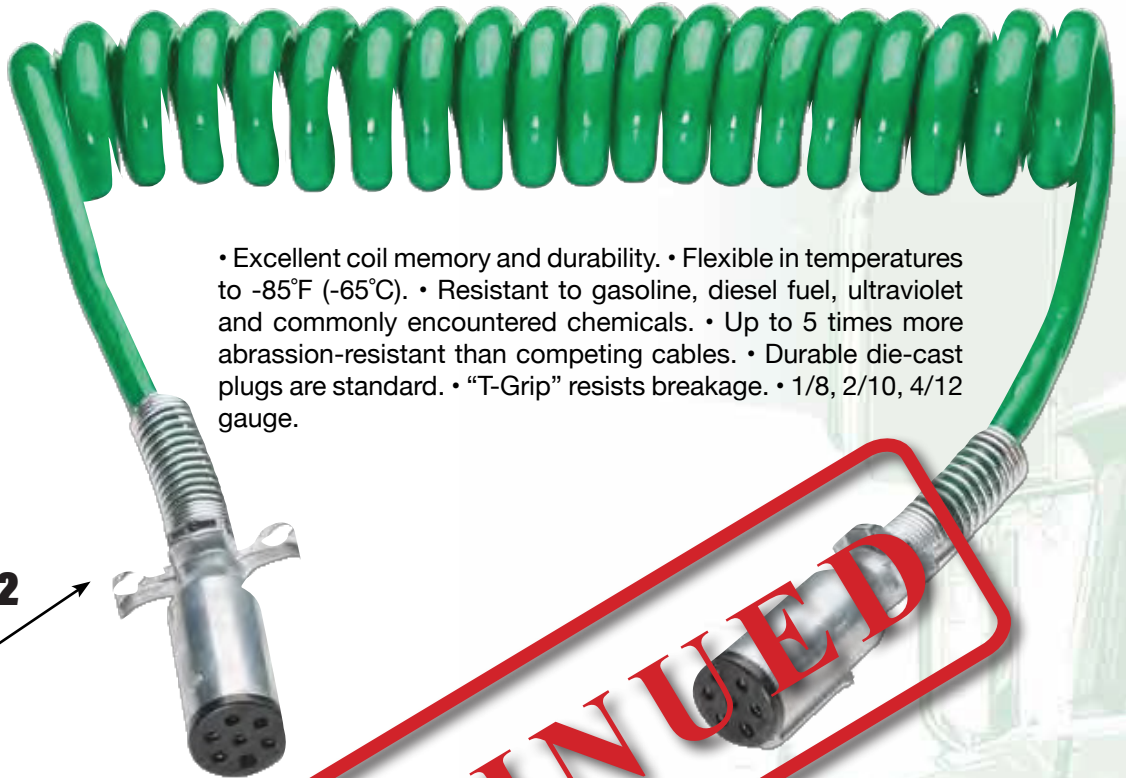

- Excellent coil memory and durability.
- Flexible in temperatures to -85°F (-65°C).
- Resistant to gasoline, diesel fuel, ultraviolet and commonly encountered chemicals.
- Up to 5 times more abrasion-resistant than competing cables.
- Durable die-cast plugs are standard.
- "T-Grip" resists breakage.
- 1/8, 2/10, 4/12 gauge.

EXCEEDS SAE J2222 STANDARD

Sealed Screw

ABS COIL ASSEMBLIES

1/8, 2/10, 4/12 Gauge

Part Number	Length	Description	Replaces Tectran	Replaces Sloan
GT-3300	12'	2 x 12" Lead	7ATG222MG	590160
GT-3301	15'	2 x 12" Lead	7ATG322MG	590161
GT-3302	15'	1-12" Lead 1-40" Lead	7ATG542MG	590163
GT-3303	20'	2 x 12" Lead	7ATG6222MG	590080
GT-3304	20'	1-12" Lead 1-40" Lead	7ATG642MW	590081

ABS STRAIGHT ASSEMBLIES

1/8, 2/10, 4/12 Gauge

Part Number	Length	Replaces Tectran	Replaces Sloan
GT-3306	12'	7AAB122MG	421166
GT-3307	15'	7AAB152MG	421167
GT-3308	20'	7AAB202MG	421247



all references to competitors' part numbers are for cross reference purposes only



Standard Duty Cables Non ABS

Seven-Way Straight Cable Assemblies

GT-3310 – Non ABS

- 15/ft. Long 12” standard lead
- Flexible from - 60°F to 150°F
- Metal zinc connectors 6/14 - 1/12” gauge **Part Number**
- All length and leads are available upon request.



	Length	Description	Replaces Tectran	Replaces Sloan
GT-3309	12”	2 x 12” Lead	7ETB522MG	42107
GT-3310	15”	2 x 12” Lead	7ETB522MG	42113
GT-3311	15”	1-12” Lead 1-15” Lead	7ETB542MG	421180



Standard Duty Cables Non ABS

Seven-Way Straight Assemblies

- Heavy-Duty zinc die cast plugs with spring guards included. 6/14 - 1/12” gauge

Part Number	Length	Replaces Tectran	Replaces Sloan
GT-3315	12”	7SAB122MG	421164
GT-3316	15”	7SAB152MG	421165



- All length and leads are available upon request.

all references to competitors' part numbers are for cross reference purposes only

Electrical



Six-Way Colled Cable Assembly

- 12' working length
- Durable black outer jacket resists abrasion and has excellent coil memory.
- Heavy-Duty zinc die cast plugs with spring guards included. **Part**

	Length	Description	Replaces Tectran	Replaces Sloan
GT-3317	12"	6 Conductor / 14 gauge	7R6122M	421165

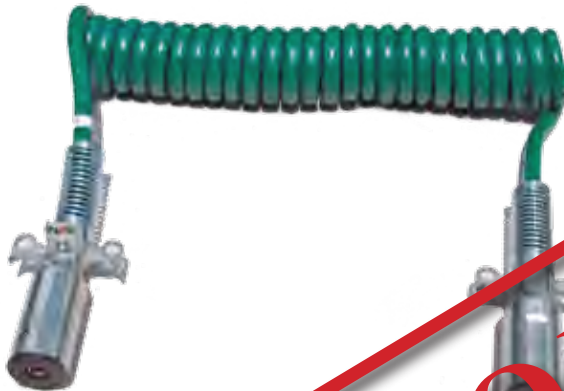

Single Pole Colled Assembly

For applications where cables are used to charge trailer lift gate batteries.

Jacket Color: Green

- 200 amp max for intermittent lift gate applications at 12 VDC
- 110 amp max for continuous applications at 12 VDC
- Heavy-Duty zinc die cast plugs with spring guards included
- External ground option
- 4 gauge cable

Part No.	Length	Description	Replaces Tectran	Replaces Sloan
GT-3324	12"	Tailgate lift battery, 4 gauge	7BTG222MG	421145
GT-3325	15"	Tailgate lift battery, 4 gauge	7BTG522MG	421146

Two Pole Colled Assembly

- Rated at 200 amps for lift gate applications at 12 VDC
- 4 gauge cable
- Internally grounded
- Withstand temperatures of -85° to + 185° F
- Durable black polyethylene outer jacket resists abrasions and chemical damage while offering excellent coil retention
- Heavy-Duty zinc die cast plugs with spring guards included

Part No.	Length	Description	Replaces Tectran	Replaces Sloan
GT-3326	12"	Two pole, 4 gauge	7DTB222MW	421172
GT-3327	15"	Two pole, 4 gauge	7DTB522MW	421173

all references to competitors' part numbers are for cross reference purposes only



Plugs



GT-3001



GT-3001G



GT-3002



GT-3004



GT-3005



GT-3006A



GT-3007B



GT-3007D



GT-3007Y



GT-3007YD

A = no spring B = with spring C = blade G = ground kit Y = plastic



Part Number	Description	Replaces Phillips	Replaces Sloan
GT-3001	1-pole plug w/spring, double grip, die cast	15-335	--
GT-3001G	1-pole plug w/spring & ground kit, double grip, die cast	15-335	--
GT-3002	2-pole plug w/spring, double grip, die cast	15-336	--
GT-3004	4-pole plug w/spring, die cast	15-430	421131
GT-3005	5-pole plug, die cast housing, chrome-plated		421133
GT-3006A	5-pole plug, no spring, die cast	15-610	421135
GT-3006B	6-pole plug w/spring, die cast	15-630	421122
GT-3007A	7-pole plug, no spring, die cast	15-710	421000
GT-3007B	7-pole plug w/spring, die cast	15-730	421001
GT-3007D	7-pole plug, blade style, car end only housing & cover (zinc)	16-713	--
GT-3007E	7-pole plug w/spring, economy, die cast	15-730	4210 01
GT-3007Y	7-pole plug, nylon	--	421147
GT-3007YD	7-pole plug, blade style, car end only ABS housing (plastic)	16-714	--

all references to competitors' part numbers are for cross reference purposes only



Sockets



GT-3010G



GT-3012



GT-3014



GT-3015



GT-3016



GT-3227



GT-3227D



GT-3227MZ



GT-3227YD



GT-3338



GT-3338K

A = no spring B = with spring D = blade G = ground kit Y = plastic

Part Number	Description	Replaces Phillips No.	Replaces Sloan
GT-3010	single pole socket, die cast	15-320	421126
GT-3010G	single pole socket w/ground kit, die cast	15-320	--
GT-3012	dual pole socket, die cast	15-326	421171
GT-3014	4-pole socket, split pin, die cast	15-400	421132
GT-3015	5-pole socket, die cast housing, chrome-plated	--	421134
GT-3016	6-pole socket, split pin, die cast	15-600	421136
GT-3227	7-pole socket, Pollack style, die cast	15-720	421015
GT-3227D	7-pole socket blade style, car end only housing & cover (zinc)	16-714	--
GT-3227MB	bracket for 7-pole connector, black E-coated	15-788	--
GT-3227MZ	bracket for 7-pole connector, zinc-plated	15-788	--
GT-3227E	7-pole socket, economy style, die cast	15-720	421015
GT-3227SP	7-pole socket, solid pin, die cast	15-721	421124
GT-3227YD	7-pole socket, blade style, car end only ABS housing & cover (plastic)	16-713	--
GT-3337	7-way base, solid diecast EZ-7 style		--
GT-3338	7-way nylon socket w/gasket split pin	(Replaces Tramec 38502W)	
GT-3338G	gasket only, for GT-3338 socket		
GT-3338K	lid kit for GT-3338 socket nylon	(Replaces Tramec 38502W)	

all references to competitors' part numbers are for cross reference purposes only



Connectors and Junction Boxes



GT-3612



GT-3613



GT-3614



GT-3614-2



GT-3615



GT-3616



GT-3624

Part Number	Description
GT-3612	2-pole flat connector, 18G wire, 12" loop
GT-3613	3-pole flat connector, 18G wire, 12" loop
GT-3614	4-pole flat connector, 18G bonded wire, 12" loop
GT-3614-2	4-pole flat connector, 18G wire, 24" loop
GT-3624	4-pole flat connector, 18G bonded wire, 12" loop, shrouded
GT-3615	5-pole flat connector, 18G bonded wire, 12" loop
GT-3616	6-pole square connector, 18G wire, 12" loop, shrouded



Electrical Junction Box

7-way Junction Box

- Box is made of high impact black UV resistant ABS plastic
- Sealing surface of lid has a unique V groove to help prohibit moisture entry
- Seven #10-32 studs supplied with nuts and lock washers
- Supplied with five grommets and two strain relief clamps
- Mounting hole centers - 7 3/8"
- Terminal connectors are coded for easy identification
- Kit includes both open and closed grommets, star washers and nuts.



Part Number	Description	Replaces Tectran
GT-3100	Standard junction box	667-7040
GT-3101	Junction box with bracket	667-7050

all references to competitors' part numbers are for cross reference purposes only

Electrical



Adapters and Protector Boots



GT-3604YD



GT-3607



GT-3706



GT-3707YD



GT-3704YD



GT-3714



GT-3715



GT-3715W

D = Blade Y = Plastic

Part Number	Description
GT-3604YD	6 to 4 way adapter, 6-way pole to 4-way flat, plastic
GT-3607	6 to 7 way adapter
GT-3704YD	7 to 4 way adapter, flat style, 7 pole round to 4 pole flat, plastic
GT-3706	7 to 6 way adapter
GT-3707YD	7 to 7 way adapter, 7 way pole to 7 way blade, plastic
GT-3714	7 to 4 way adapter, 7 way round to 4 way flat inline female w/cover
GT-3715	7 to 5 way adapter, 7 way blade to 5 way flat inline female
GT-3715W	7 to 5 way adapter, 7 way blade to 5 way flat inline female 2 ft wire



GT-3200



GT-3202

Part Number	Description	Replaces Phillips
GT-3200	Electrical plug protector boot fits GT-3227, GT-3227E, and GT-3227SP	15-740
GT-3202	Electrical socket protector boot 2" x 3" hole mount	

all references to competitors' part numbers are for cross reference purposes only



Rubber Cushlon Clamp



Part Number	Width	Clamping DIA.	Screw Size	Replaces Phillips
GT-35044	1/2"	1/4"	1/4"	5-45044
GT-35064	1/2"	3/8"	1/4"	5-45064
GT-35084	1/2"	1/2"	1/4"	5-45084
GT-35104	1/2"	5/8"	1/4"	5-45104
GT-35124	1/2"	3/4"	1/4"	5-45124
GT-35154	1/2"	1"	1/4"	5-45164
GT-36044	5/8"	1/4"	3/8"	5-46044
GT-36064	5/8"	3/8"	3/8"	5-46064
GT-36084	5/8"	1/2"	3/8"	5-46084
GT-36104	5/8"	5/8"	3/8"	5-46104
GT-36124	5/8"	3/4"	3/8"	5-46124
GT-36164	5/8"	1"	3/8"	5-46164
GT-36241	5/8"	1-1/4"	3/8"	5-46241
GT-36271	5/8"	1-1/2"	3/8"	5-46271
GT-36281	5/8"	2"	3/8"	5-46281
GT-36291	5/8"	2-1/2"	3/8"	5-46291
GT-36301	5/8"	3"	3/8"	5-46301
GT-36302	5/8"	4"	3/8"	--
GT-36304	5/8"	5"	3/8"	--

Electrical

Wire Clip

Plastisol dipped coating



Part Number	Description	Replaces Wabash
GT-3401	Small Wire Clip	2120046
GT-3403	Large wire clip	2120005

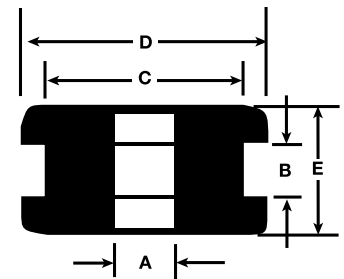

Rubber Grommet



Part No.	A Inside Diameter	B Groove Width	C Drill Diameter	D Outside Diameter	E Overall Thickness
GT-7710	5/16"	1/16"	7/16"	9/16"	3/16"
GT-7711	1/2"	1/4"	1"	1-3/8"	1/2"
GT-7712	3/5"	1/8"	24/25"	1-1/4"	6/16"
GT-7713	21/29"	1/5"	1-3/16"	1-3/4"	1/2"

all references to competitors' part numbers are for cross reference purposes only



Zinc Die-Cast 7-Way Socketbreakers

- Heavy-Duty die-cast material
- 2 Hole mount with gasket included
- 7 pole, split-pin with a full-open lid
- available with metal or nylon circuit breakers.



GT-3017-G

Part Number	Description	Replaces Grote	Pack Size
GT-3017-15	15 amp, metal breakers, split pin	82-0854	1
GT-3017-20	20 amp, metal breakers, split pin	82-0855	1
GT-3017-20K	20 amp, metal breakers, split pin, with nosebox & gasket	82-0855	1 (kit)
GT-3017-30	30 amp, metal breakers, split pin	82-0856	1
GT-3017-15P	15 amp nylon breakers, split pin	--	1
GT-3017-20P	20 amp, nylon breakers, split pin	82-0857	1
GT-3017-30P	30 amp, nylon breakers, split pin	82-0858	1
GT-3017-	No circuit breakers, split pin	82-0853	1



BACK

FRONT

DISCONTINUED

Poly Split Looms



100 Foot Rolls

Part Number	Description
GT-3801	1/4"
GT-3802	3/8"
GT-3803	3/8"
GT-3803-R	red, 1/2"
GT-3803-G	gray, 1/2"
GT-3804	5/8"

Part Number	Description
GT-3805	3/4"
GT-3806	1"
GT-3807	1-1/4"
GT-3808	1-1/2"
GT-3809	1-7/8"
GT-3810	2"

all references to competitors' part numbers are for cross reference purposes only



Circuit Breakers and Switches

Circuit Breakers

Part Number	Description	Replaces Tectran
GT-3550	15 amp circuit breaker metal	660-15
GT-3551	20 amp circuit breaker metal	660-20
GT-3552	25 amp circuit breaker metal	660-25
GT-3553	30 amp circuit breaker metal	660-30
GT-3550P	15 amp circuit breaker plastic	661-15
GT-3551P	20 amp circuit breaker plastic	661-20
GT-3552P	25 amp circuit breaker plastic	661-25
GT-3553P	30 amp circuit breaker plastic	661-30



Metal
Plastic

Electrical

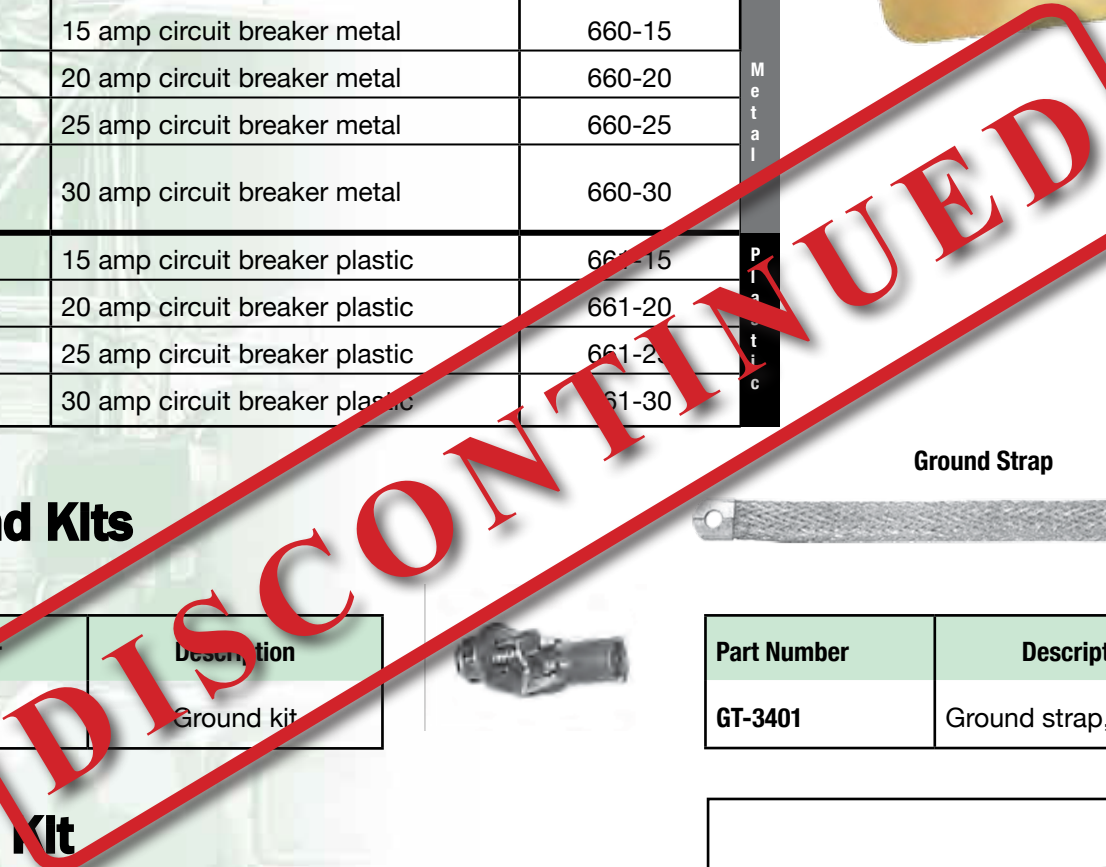

Ground Kits

Part Number	Description
GT-3400	Ground kit



Ground Strap



Part Number	Description
GT-3401	Ground strap, 12" 4 ga

Brush Kit

GT-3201

Male & Female
Cleaning kit for 7-way plugs and sockets

Replaces: Tectran 5031



all references to competitors' part numbers are for cross reference purposes only



Electrical Connectors

Zinc Die-Cast Deep Nosebox

- 55% more interior space than the GT-3203.
- Larger interior space allows for easier access & maintenance.
- 3-1/8" deep.

- Fits 15 series and 16 series socketbreakers.
- Standard hole pattern.
- Kit includes gasket, grommet and socketbreaker mounting hardware.
- Does not include nosebox mounting hardware.



**GT-3204
Deep Nosebox Kit**

Part Number	Description	Replaces Phillips
GT-3203	Zinc die-cast nosebox kit	15-769
GT-3203-G	Gasket for nosebox	15-767
GT-3203-D	Grommet for nosebox	15-765
GT-3204	Zinc die-cast deep nosebox kit	15-775
GT-3204-G	Gasket for deep nosebox	--
GT-3204-D	Double grommet for deep nosebox	--
GT-3017-G	Gasket for socketbreaker	15-766

**GT-3204-D
Double
Grommet**



**GT-3203
Standard Nose Box Kit**

GT-3203 Standard Nosebox

- 1 7/8" deep.
- For use with 15 series or 16 series socketbreakers.
- Kit includes gasket, grommet and socketbreaker mounting hardware.
- Does not include nosebox mounting hardware.

Nylon Deep Nosebox

- 55% more interior space than the GT-3203.
- Larger interior space allows for easier access & maintenance.
- 3-1/8" deep.
- Fits 15 series and 16 series socketbreakers.
- Standard hole pattern.
- Kit includes gasket, grommet and socketbreaker mounting hardware.
- Does not include nosebox mounting hardware.



**GT-3205 Nylon Deep
Nosebox Kit**



all references to competitors' part numbers are for cross reference purposes only



Rubber Tractor Lamps

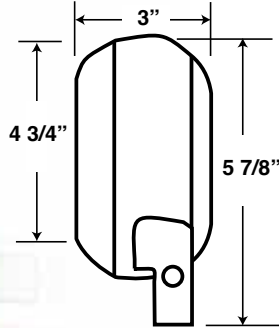

- 4-3/8" round housing with swivel base
- Sealed beam
- Par 36
- 12v 55w halogen bulb

Part Number	Description	Replaces
GT-7450	Rubber tractor lamp	TL80360

License Plate Lights

Part Number	Description	Replaces
GT-7460	License plate light, zinc-plated	TL26330
GT-7461	License plate light, chrome-plated	



Visit our website for discontinued/overstock parts availability
www.gtmanufacturing.com/discontinued-overstock-parts



all references to competitors' part numbers are for cross reference purposes only

Electrical



GT-4009 SERIES HUB CAPS 380 ALUMINUM ALLOY

G - Dirt exclusion grease hub cap
S - Side fill for oil
H - Hubodometer with side fill
K - Includes gasket

Part Number		Size	Gasket	Window Kit	Replaces
 GT-4009	GT-4009 Standard hub cap without side fill *Does not Include gasket	<ul style="list-style-type: none"> • NO. Bolts 6 • Bolt Circle: 5.5" • Bolt Size: 5/16" • Overall Depth: 2-11/16" • Inside Depth: 1-15/16" • Flange I.D.: 4-3/8" • Flange O.D.: 6-1/4" 	GT-4006	GT-4003	STEMCO 340-4009
	GT-4009K Standard hub cap without side fill *Includes gasket				
 GT-4009G	GT-4009G Dirt exclusion grease hub cap *Does not include gasket		GT-4006	GT-4000	STEMCO 342-4009
	 GT-4009SK		GT-4009S Standard hub cap with side fill *Does not include gasket GT-4009SK Standard hub cap with side fill *Includes Gasket	GT-4006	GT-4003
GT-4009H	GT-4009H Hubodometer hub cap with side fill *Does not include gasket		GT-4006	GT-4002	STEMCO 347-4009

Test Procedure: Sample preparation and chemical analysis were conducted in accordance with standard laboratory procedures. Hardness testing was conducted in accordance with ASTM E18-03

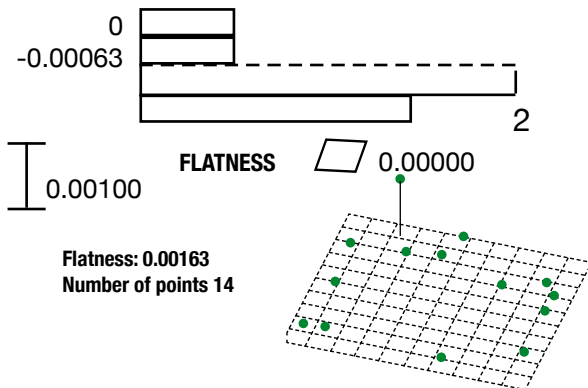

All Globtech Hub Caps test less than .002 flatness

Test Results:

Chemical Analysis (percentage)

Manganese	0.16
Silicon	8.68
Nickel	0.08
Chromium	0.04
Copper	3.06
Aluminum	0.04
Magnesium	0.07
Iron	1.06
Titanium	0.03
Zinc	1.18
Tin	0.02
Material Included:	380 Aluminum Alloy
Mechanical Properties	
Hardness	HRB 45

all references to competitors' part numbers are for cross reference purposes only



WHEEL END

Globetech's standard hub caps are die-cast from a 380 aluminum alloy. They resist cracking, warping and breaking in any conditions.

- Each hub cap is individually poly-bagged.
- Vent plug is molded in a nitrile rubber.
- Dow Corning CALIBRE lens, UV-stabilized.

G - Dirt exclusion grease hub cap
 S - Side fill for oil
 H - Hubodometer with side fill
 K - Includes gasket

Part Number		Size	Gasket	Window Kit	Replaces
 GT-4007F	GT-4007 Stamped Steel without filler vent	<ul style="list-style-type: none"> • NO. Bolts: 6 • Bolt Circle: 4.5" • Bolt Size: 5/16" • Overall Depth: 2 • Inside Depth: 1-15/16" • Flange I.D.: 3-5/16" • Flange O.D.: 5-3/16" 	GT-4006	N/A	STEMCO 340-5097
	GT-4007F Stamped Steel with filler vent				STEMCO 340-5096
Part Number		Size	Gasket	Window Kit	Replaces
 GT-4013	GT-4013 Hub cap without side fill *Does not include gasket	<ul style="list-style-type: none"> • NO. Bolts 5 • Bolt Circle: 5.5" • Bolt Size: 5/16" • Overall Depth: 2-11/16" • Inside Depth: 1-15/16" • Flange I.D. : 4-3/8" • Flange O.D.: 6-1/4" 	GT-4004	GT-4003	STEMCO 340-4013
Part Number		Size	Gasket	Window Kit	Replaces
 GT-4024	GT-4024 Hub cap without side fill *Does not include gasket	<ul style="list-style-type: none"> • NO. Bolts: 6 • Bolt Circle: 4.5" • Bolt Size: 5/16" • Overall Depth: 2-5/8" • Inside Depth: 1-7/8" • Flange I.D.: 3-1/2" • Flange O.D.: 5-1/4" 	GT-4025	GT-4005	STEMCO 340-4024
	GT-4024S Hub cap with side fill *Does not include gasket			GT-4005	STEMCO 343-4024
Part Number		Size	Gasket	Window Kit	Replaces
 GT-4195	GT-4195 Hub cap without side fill *Does not include gasket	<ul style="list-style-type: none"> • NO. Bolts: 6 • Bolt Circle: 6.75" • Bolt Size: 5/16" • Overall Depth: 3-11/16" • Inside Depth: 2-15/16" • Flange I.D.: 5-7/16" • Flange O.D.: 7-1/2" 	GT-4008	GT-4003	STEMCO 340-4195
	GT-4195G Dirt exclusion grease hub cap *Does not include gasket			GT-4000	STEMCO 342-4195
	GT-4195S Hub cap with side fill *Does not include gasket			GT-4003	STEMCO 343-4195
	GT-4195H Hubodometer hub cap with side fill *Does not include gasket			GT-4002	STEMCO 347-4195

Wheel End

all references to competitors' part numbers are for cross reference purposes only



Part Number		Size	Gasket	Window Kit	Replaces
	GT-4249S Hub Cap with side fill, 4-3/8" Window *Does not include gasket	<ul style="list-style-type: none"> • NO. Bolts 6 • Bolt Circle: 5.5" • Bolt Size: 5/16" • Overall Depth: 1-13/16" • Inside Depth: 1-11/16" • Flange I.D.: 4-7/16" • Flange O.D.: 6-3/16" 	GT-4006	GT-4912	STEMCO 343-4249
Part Number		Size	Gasket	Window Kit	Replaces
	GT-4095 Hub cap with out side fill *Does not include gasket	<ul style="list-style-type: none"> • NO. Bolts 6 • Bolt Circle: 5.5 • Bolt Size: 5/16 • Overall Depth: 1-13/16 • Inside Depth: 1-1/16 • Flange I.D.: 4-9/16 • Flange O.D.: 6-3/16 	GT-4006	GT-4003	STEMCO 340-4095
	GT-4095S Hub cap with side fill *Does not include gasket				STEMCO 343-4095
Part Number		Size	Gasket	Window Kit	Replaces
	GT-4075 Hub cap with out side fill *Does not include gasket	<ul style="list-style-type: none"> • Bolt Circle: 6-1/4" x 8 UN (M) • Bolt Size: 5/16" • Overall Depth: 2-5/16" • Inside Depth: 1-9/16" • Flange I.D.: 5-3/4" • Flange O.D.: 6-7/8" 	GT-4021	GT-4003	STEMCO 340-4075
Part Number		Size	Gasket	Window Kit	Replaces
	GT-4640 Lexan hub cap	<ul style="list-style-type: none"> • NO. Bolts 6 • Bolt Circle: 5.5" • Bolt Size: 5/16" • Overall Depth: 2-11/16" • Inside Depth: 1-15/16" • Flange I.D.: 4-3/8" • Flange O.D.: 6-1/4" 	GT-4006	N/A	Sirco 9018
	GT-4640H Lexan hubodometer hub cap				Stemco 640-0001 Sirco 9020
Part Number		Size	Bolt Circle Dia.		Replaces
	GT-4065 Hubodometer Bracket	Fits over all hubcaps ending in 4009 • Stud Size 5/16" - 18 Thread • Height 3 1/2"	5-1/2"		Stemco 610-0065
Part Number		Size	Bolt Circle Dia.		Replaces
	GT-4084 Hubodometer Bracket	Fits PSI Hubcap and 4195 • Stud Size 5/16" • Height 5"	6-3/4"		Stemco 610-0084

all references to competitors' part numbers are for cross reference purposes only



WHEEL END

PRO PAR STYLE CAPS



Non Vented

GT-4020B	Specifications	Interchanges
Hub Cap For Fruehauf Propar Includes: Center plug O-Ring	Thread 6/1/4" Size 8 Material: Polycarbonate Replaces Fruehauf ACC-7538-900	Batco 11-0670 BWP M-1052 Euclid E-04075 Leland L-885 Meritor R004075 Sirco 9013 Spicer 8-295 Stemco 340-4975



Vented

GT-4020	Specifications	Interchanges
Hub Cap Vented For Fruehauf Propar Includes: Vented plug O-Ring	Thread 6/1/4" Size 8 Material: Polycarbonate Replaces Fruehauf ACC-7538-900	Euclid E-04075V



Hubodometer

GT-4020H	Specifications	Interchanges
Hub Cap Hubodometer Version For Fruehauf Propar Includes: O-Ring Side fill plug	Thread 6/1/4" Size 8 Material: Polycarbonate Replaces Fruehauf ACC-6113-900	Batco 11-0671 BWP M-2764 Euclid E-04075H Sirco 9015 Spicer 8-295H Stemco 640-0003

all references to competitors' part numbers are for cross reference purposes only



WINDOW KITS



GT-4000



GT-4002



Part Number	Description	Replaces
GT-4003	3-1/2" window Dia.	Batco 11-0675 Stemco 359-5995
GT-4005	2-3/4" window Dia.	Stemco 359-5999
GT-4002	Hubo window for 4009 Series	359-6117
GT-4000	Grease cap window	359-6095
GT-4912	4-3/8" window Dia.	359-5912

Part Number	Description	Replaces
GT-4021	O-Ring Use with GT-4020 & GT-4075 6" O.D. 5-1/2" I.D.	Batco 11-0680 BWP M-1065 Euclid E-05500 Meritor Roo5500 Leland L-1700 Spicer 8-29F Stemco 330-3077

PLUGS

↑
.70"
↓



GT-4001RED

Propar Style

↑
1"
↓



Part Number	Description	Replaces
GT-4001RED	GT-4001 Red Vented Plug	
GT-4001V	GT-4001V Black Vented Plug	359-5990
GT-4001NV	GT-4001NV Black Non-Vented Plug	BWP M-1066
GT-4014V	GT-4014V Black Vented Plug	Euclid E-04000 Sirco
GT-4014NV	GT-4014NV Black Non-Vented Plug	B-9015 E-04000V B-9015V

all references to competitors' part numbers
are for cross reference purposes only



GASKETS

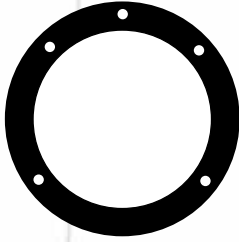

Part Number	Size	Replaces
GT-4025 Use with 4024 series Hub Caps	6 - Hole Small Gasket 4-1/2" B.C.	Batco 13-7156 BWP Euclid Leland Meritor Spicer Stemco 330-3024

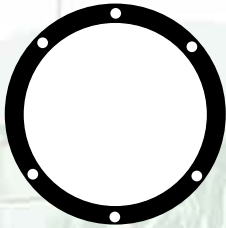

Part Number	Size	Replaces
GT-4006 Use with 4009, 4098, 4095 series Hub Caps	6 - Hole 6-13/16" O.D. 4-5/16" I.D. 5-1/2" B.C.	Batco 13-7151B BWP M-2768 Euclid Leland L-453 Meritor Spicer 8-304 Stemco 330-3009

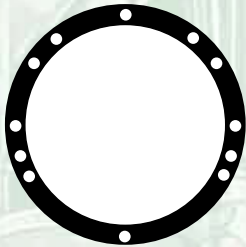

Part Number	Size	Replaces
GT-4004 Universal	12 - Hole 3, 5, 6, Hole 6-3/8" O.D. 4-7/16" I.D. 5-1/2" B.C.	Batco 13-7150B BWP M-837 Euclid E-03009 Leland Meritor Spicer Stemco 330-3067

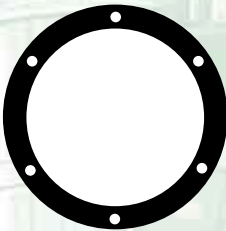

Part Number	Size	Replaces
GT-4008 TP Axle Gasket Use with 4195 Hubcap	6 - Hole 7-1/2" O.D. 5-7/16" I.D. 6-3/4" B.C.	Batco BWP Euclid Leland Meritor Stemco 330-3118 Wabash 10600483

Description: GT-8011 is a low density cellulose fiber material with high rubber filler content and a nitrile butadiene rubber binder. It provides excellent sealing of oil and water at low flange pressures, and is used primarily for engine and transmission pan gaskets, water pumps, and environmental seals. It is intended for applications with short duration maximum temperatures up to 180°C (350°F). GT-8011 has UL component recognition.

Density, g/cc(lb/cu.ft)	0.61 (38) (min.)	ASTM F 1315
Compressibility, % (at 6.9MPa)	35 - 60	ASTM F 36
Recovery, %	15 (min.)	ASTM F 36
Tensile Strength, AMD, MPa (psi)	1.52 (220) (min.)	ASTM F 152
Fluid Resistance, IRM903 Oil		ASTM F 146
Change in Weight, %	120 (max.)	
Fluid Resistance, Fuel B		ASTM F 146
Change in weight, %	120 (max.)	
Fluid Resistance, Distilled Water		ASTM F 146
Change in Weight, %	45 (max.)	
Binder Type	Nitrile Butadiene	

all references to competitors' part numbers are for cross reference purposes only



TEMPBOLT™

Patented

Avoid expensive bearing failures, unscheduled down time, costly road service calls and missed delivery appointments. Install the new **Globetech TempBolt™** in the hubcaps of your tractors and trailers today.

A **Globetech TempBolt™** installed in your hubcap can warn you of pending bearing problems. The TempBolt's visual red indicator pops out if the hub temperature reaches or exceeds 250° F. Only one **TempBolt™** is needed for each hubcap. This product is not a replacement for a rigorous hub preventive maintenance program.

- Tested and Approved by the TRUCK OEM Technical Center
- Several brake drag-tests were conducted to test drum temperature effect on the TempBolt™. The TempBolt™ did not activate due to high drum temperature. Only when the HUB exceeds 250° F does it activate.
- Anytime the oil temperature is consistently over 300° F, bearing failure can occur. At this temperature the oil will lose its lubricity causing the bearings to create more heat and eventually fail.
 - With the activation temperature set at 250° F, the **TempBolt™** warns you BEFORE a failure occurs.
 - In a typical operation, hub oil temperature runs between 150-200° F.
 - The **Globetech TempBolt™** can be used in any hub (tractor or trailer) that has a 5/16" diameter hubcap bolt.
 - When installing, do not exceed 14 ft. lbs. torque.

The **Globetech TempBolt™** is available in a "point-of purchase" display box, containing 50 individual bags of 4 bolts. Encourage your customers to make it part of their preventative maintenance program.



GT-7600 BLK (Bulk)



GT-7600 (Single pkg.)



GT-7600B – (Tempbolt display Kit)
(incl. 50 pkg.)

all references to competitors' part numbers are for cross reference purposes only



WHEEL END

WHEEL PARTS INNER/OUTER NUTS



Inner Nut



Outer Nut

	Part Number	Dayton Batco	BWP	Euclid	Sirco	Description	Plating
I N N E R	GT-4E5988L	13-3026L	M-2401	E5988L	98AL	For dual mounted aluminum wheels Outer thread 1 1/8" - 16 Inner thread 3/4" - 16 Inner thread min. depth 1 15/16" Outer overall length 3 1/16"	Zinc Clear
	GT-4E5988R	13-3026R	M-2400	E5988R	988AR		
	GT-4E7895L	13-3005L	M-129	E7895L	709AL	For dual mounted steel & aluminum wheels Outer thread 1 1/8" - 16 Inner thread 3/4" - 16 Inner thread min. depth 1 1/4" Outer overall length 2 7/32"	
	GT-4E7895R	13-3005R	M-128	E7895R	708AR		
	GT-4E7896L	13-3028L	M-131	E7896L	896L	For dual mounted steel & aluminum wheels Outer thread 1 1/8" - 16 Inner thread 3/4" - 16 Inner thread min. depth 1 1/4" Outer overall length 2 9/16"	All Zinc Yellow
	GT-4E7896R	13-3028R	M-130	E7896R	896R		
	GT-4E5568L	13-3029L	M-133	E5568L	897L	For dual mounted steel & aluminum wheels Outer thread 1 1/8" - 16 Inner thread 3/4" - 16 Inner thread min. depth 1 7/8" Outer overall length 3 1/16"	
	GT-4E5568R	13-3029R	M-132	E5568R	897R		
O U T E R	GT-4E5977L	13-3012L	M-127	E5977L	892AL	Left and right outer nuts for all part numbers listed.	
	GT-4E5977R	13-3012R	M-126	E5977R	891AR		

DISCONTINUED

Wheel End

all references to competitors' part numbers are for cross reference purposes only



TWO PIECE METRIC NUT



GT-46000A

Description	THRD	HEX	High	Replaces
Metric 2-Piece Budd Unimount 10 Hub Piloted Wheels Teflon Coated	M 22 X 1.5	33 mm (1-19/64")	31 mm (1-7/32")	Euclid E-6000A Meritor R006000 Spicer 51-1033 Sirco 333B

PRO-PAR AXLE NUTS & WASHERS



GT-41226

Description: Pro-Par Axle Outer Nut
Measurements: 4-3/4" x 3-1/2"-12 x 1-1/8"
Quality: grade 8 Material: SAE 1040/1050

REPLACES: Martec: 1227D1226 Eaton: 4-2202
FRUACE8510-1 Trailmobile: 700-7-14



GT-43068

Description: Pro-Par Axle Washer
Measurements: 3-1/2" I.D. 5-1/16" O.D. x .255 thick

REPLACES: Martec: 1229E3068
Trailmobile: 700-7-15

PREMIUM ALUMINUM GASKETS



GT-4AG2106



GT-4AG2107



GT-4AG2111

Part Number	Holes	Description	Replaces Stemco
GT-4AG2106	8	Premium Aluminum Gasket 8 Hole 7" 5/8" Bolts 8-1/4" OD 6" ID	330-3106
GT-4AG2107	8	Premium Aluminum Gasket 8 Hole 7" 3/4" Bolts 8-1/2" OD 5-5/8" ID	330-3107
GT-4AG2111	8	Premium Aluminum Gasket 8 Hole 7" 5/8" Bolts 8-3/8" OD 5-3/4" ID	330-3111

all references to competitors' part numbers are for cross reference purposes only



HUBCAPS

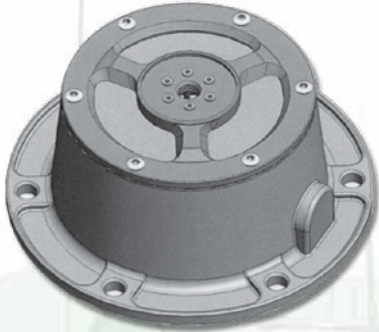

GT-4370

PSI, TN HUBCAP, GREASE, WITH SIDE FILL, W/NYLON WINDOW

Replaces Stemco: 340-4350 or 340-4370

Replaces Meritor: 31426-00

- Application: Grease
- Bolt Circle: 5.5
- Bolt Size: 5/16
- Overall Depth: 2-11/16
- Inside Depth: 1-15/16
- Flange Inner Diameter: 4-3/8
- Flange Outer Diameter: 6-1/4
- Replacement Window Kit: 359-6141

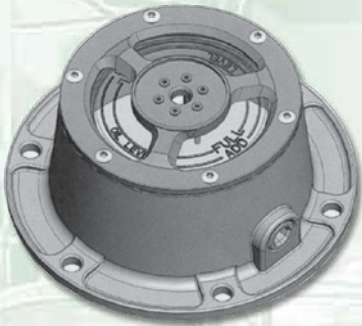

GT-4370S

PSI, TN HUBCAP, OIL, WITH SIDE FILL, W/NYLON WINDOW

Replaces Stemco: 343-4350 or 343-4370

Replaces Meritor: 31427-00

- Application: OIL
- Bolt Circle: 5.5
- Bolt Size: 5/16
- Overall Depth: 2-11/16
- Inside Depth: 1-15/16
- Flange Inner Diameter: 4-3/8
- Flange Outer Diameter: 6-1/4
- Replacement Window Kit: 359-6141

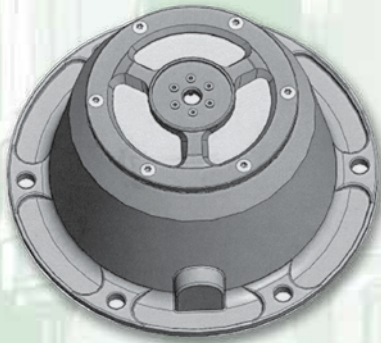

GT-4372

PSI, TN HUBCAP, GREASE, NO SIDE FILL, W/NYLON WINDOW

Replaces Stemco: 340-4352 or 340-4372

- Application: Grease
- Bolt Circle: 6.75
- Bolt Size: 5/16
- Overall Depth: 3-11/16
- Inside Depth: 2-15/16
- Flange Inner Diameter: 5-7/16
- Flange Outer Diameter: 7-1/2
- Replacement Window Kit: 359-6141

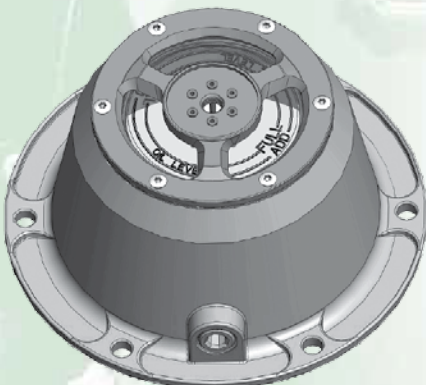

GT-4372S

PSI, TN HUBCAP, GREASE, WITH SIDE FILL, W/NYLON WINDOW

Replaces Stemco: 343-4352 or 343-4372

- Application: OIL
- Bolt Circle: 6.75
- Bolt Size: 5/16
- Overall Depth: 3-11/16
- Inside Depth: 2-15/16
- Flange Inner Diameter: 5-7/16
- Flange Outer Diameter: 7-1/2
- Replacement Window Kit: 359-6141



TIRE INFLATION HOSE



GT-4120

Long Flex Hose

Replaces:
MTR31373-00

Standard Length 17.5" inches
*Also available in 19.5" inches

WORKS WITH ALL TIRE INFLATION SYSTEMS



GT-4121

Replaces:
MTR31363-00



GT-4123

Replaces:
810-0059



GT-4122

Replaces:
810-0060

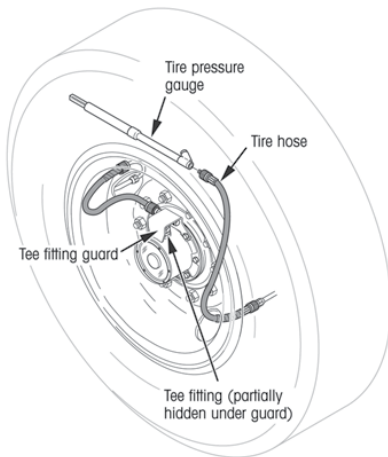

Wheel End



INNER TUBE GT-4300 (BLUE LINE)



VALVE STEM: TR78A

Brass angled

STZF: 1000-20

Material: Butyl Blue line (High Tensile)
8-10 mpa

Packaged: Poly Bag 7 tubes per box

Part Number	Description
GT-4300	Standard 1000x20 8 MPA
GT-4302	Premium 1000x20 10 MPA
GT-4301	Tire flap liner

DISCONTINUED

TIRE REPAIR TOOL KIT GT-4040

- 1pc-Heavy Duty steel T-handle Insert tool
- 1pc-Heavy-Duty steel T-handle spiral probe cement tool
- 2pc-replacement tool
- 60pc-4" string/plugs
- 1pc-lubricating oil



Wheel End



TIRE INFLATOR KIT

1/4" straight air hose for air tool (or other low pressure pneumatic applications)
 Self-storing, 50 foot length
 2 x 1/4" NPTF male swivel fittings with spring guards are included
 300 psi is maximum recommended operating pressure at 78°F
 OSHA (STD1-13-001) compliant when used with safety tip only
 Inflator Kit Includes Coil Assembly and:
 1/2" x 1/4" Bushing
 Male End Connector
 Female Disconnect
 Universal Gladhand (Part No. 5330)
 Air Chuck (Part No. 451060)
 Blow Gun w/male disconnect (Part No. 451065)



GT-451070



NEW PART

GT-14210

FIFTH WHEEL SLIDER COIL

Part Number	Description	Replaces Tectran
GT-14210	Fifth Wheel Slider Coil	14210



GT-451065

BLOW GUN

Part Number	Description	Replaces Tectran
GT-451065	Blow gun w/male disconnect, 1/4" NPT	A148



GT-45130

TIRE CHUCKS/TIRE GAUGES

Part Number	Description	Replaces Tectran
GT-45130	6" dual foot air chuck. 1/4" NPT	A824
GT-45135	Dual foot tire gauge, nylon bar, 10-150 psi	6A135



GT-45135

all references to competitors' part numbers are for cross reference purposes only



VALVE STEMS - USE: STEEL WHEELS



Part Number	Length	Replaces
GT-TR501	1-1/2"	Haltec TV-501
GT-TR572	3-3/4"	Haltec TV-572
GT-TR573	4-3/8"	Haltec TV-573

VALVE STEMS - USE: ALUMINUM WHEELS



Part Number	Length	Bend Angle	Replaces
GT-TR544D	2"	90°	Haltec TV-544D
GT-TR545D	2-5/8"	60°	Haltec TV-545D
GT-TR509	4-3/4"	90°	Haltec TV-509
GT-TR510	5-1/2"	90°	Haltec TV-510

DISCONTINUED

VALVE STEMS - USE: STEEL WHEELS



Part Number	Description	Replaces
GT-TE382	5-1/16" valve extension with 1" collar	Haltec 382

Wheel End

all references to competitors' part numbers are for cross reference purposes only



VALVE STEM ACCESSORIES



GT-DS-1

Metal Double Seal Cap

This double seal cap seals at the top of the cap which prevents dirt and water from penetrating the cap, eliminating the chances of clogged air passages due to ice and debris. Allows for inflation and deflation of the tire without removing the cap. A great time saver.

Replaces Haltec DS-1



GT-VC-3



GT-VC-8

VALVE CAPS (STANDARD BORE)



GT-VC-1

Part Number	Description	Replaces
GT-VC-3	Nickel plated	Haltec A 100-VC-3
GT-VC-8	Black plastic	Haltec A-100-VC-8

Valve Core

Part Number	Description	Replaces
GT-VC-1	Standard bore heat resistant core for cars, trucks and buses	Haltec A 100-VC-1

STANDARD BORE 4-WAY VALVE TOOL



Part Number	Description	Replaces
GT-TL610	Repairs and conditions inside and outside valve threads. Inserts and removes cores. Corrosion-resistant, cadmium-plated	Haltec A 100-VC-1

all references to competitors' part numbers are for cross reference purposes only



FREEZE PLUGS GT-6200

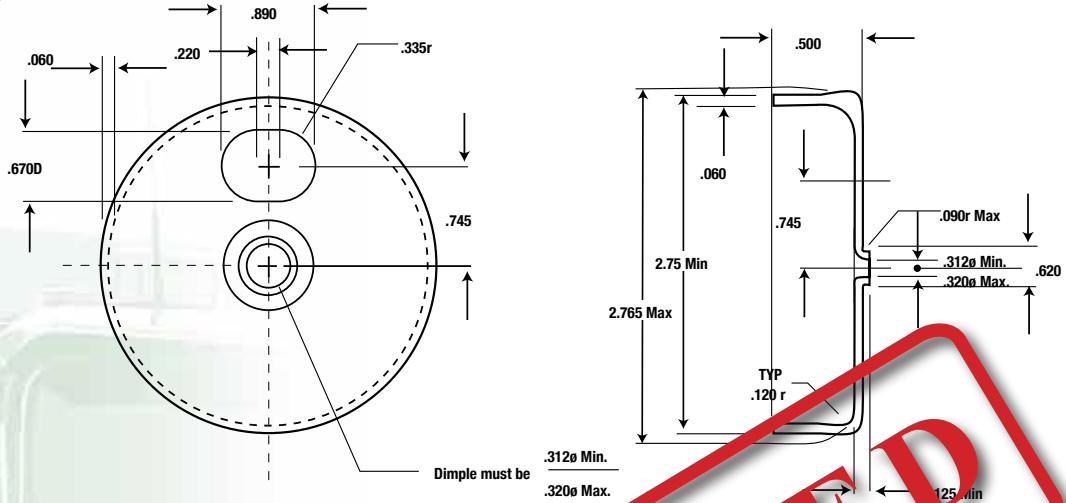

Part Number	Description	Replaces
GT-6200	Freeze plug	Wabash 10600526

FREEZE PLUGS GT-6202

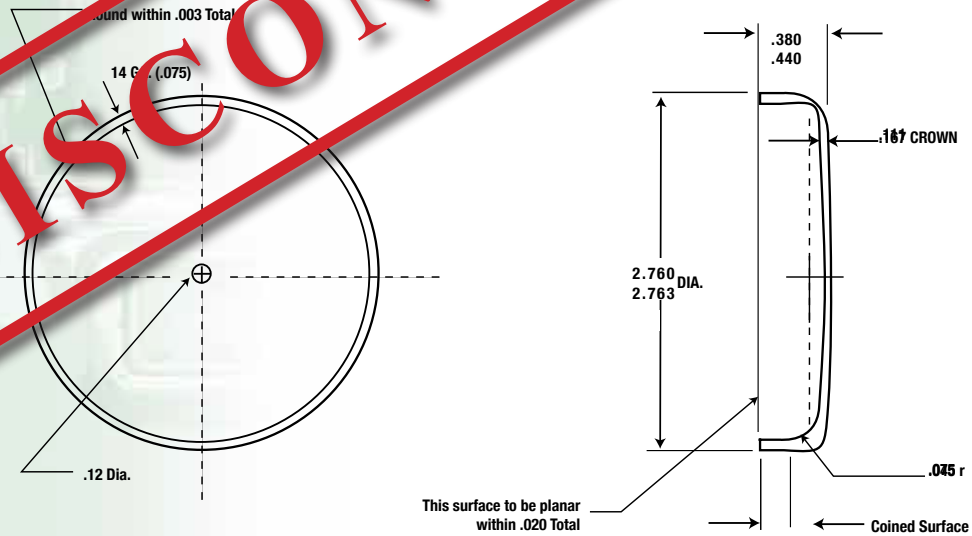

Part Number	Description	Replaces
GT-6202	Freeze plug	Haldex 102434T Fruehauf A-CD7180-1

all references to competitors' part numbers are for cross reference purposes only

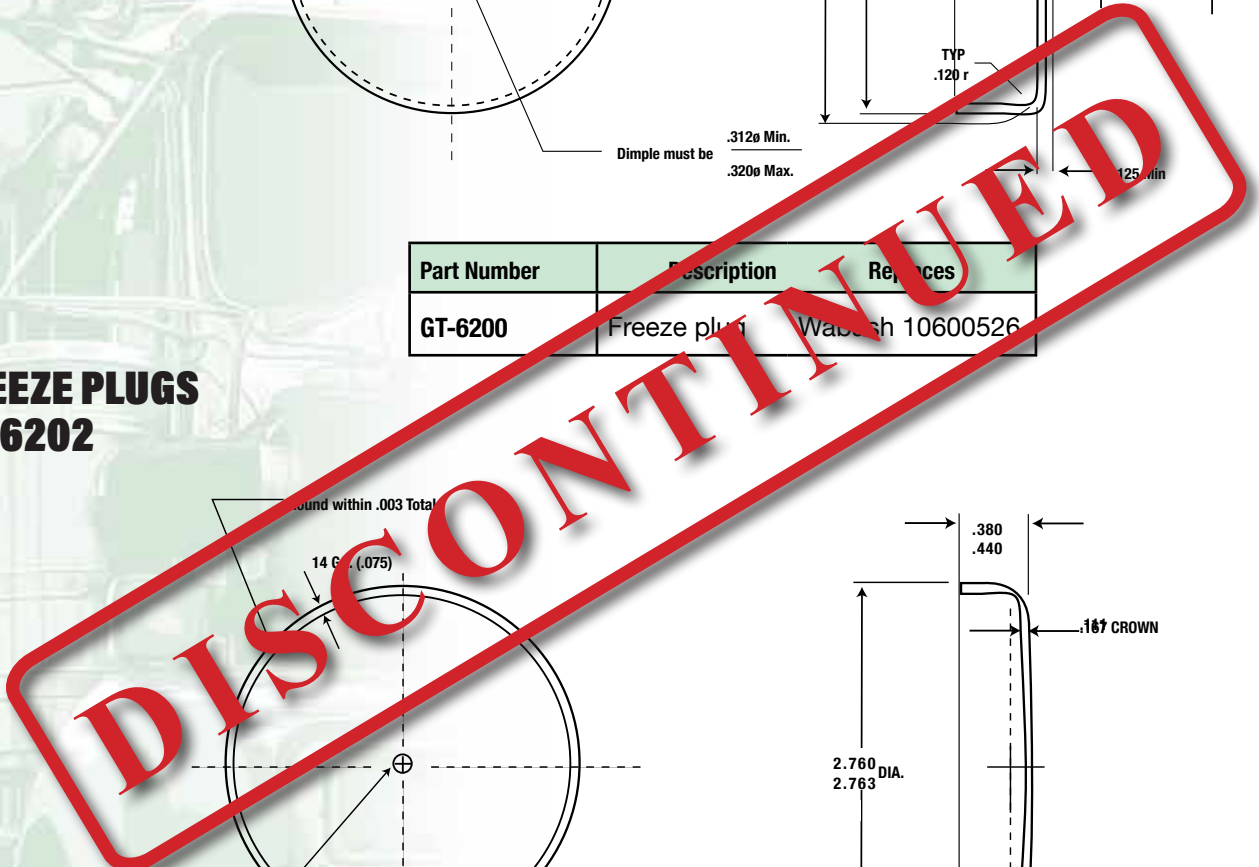

Wheel End

ABS GEN2

Trailer Anti-Lock
Braking System

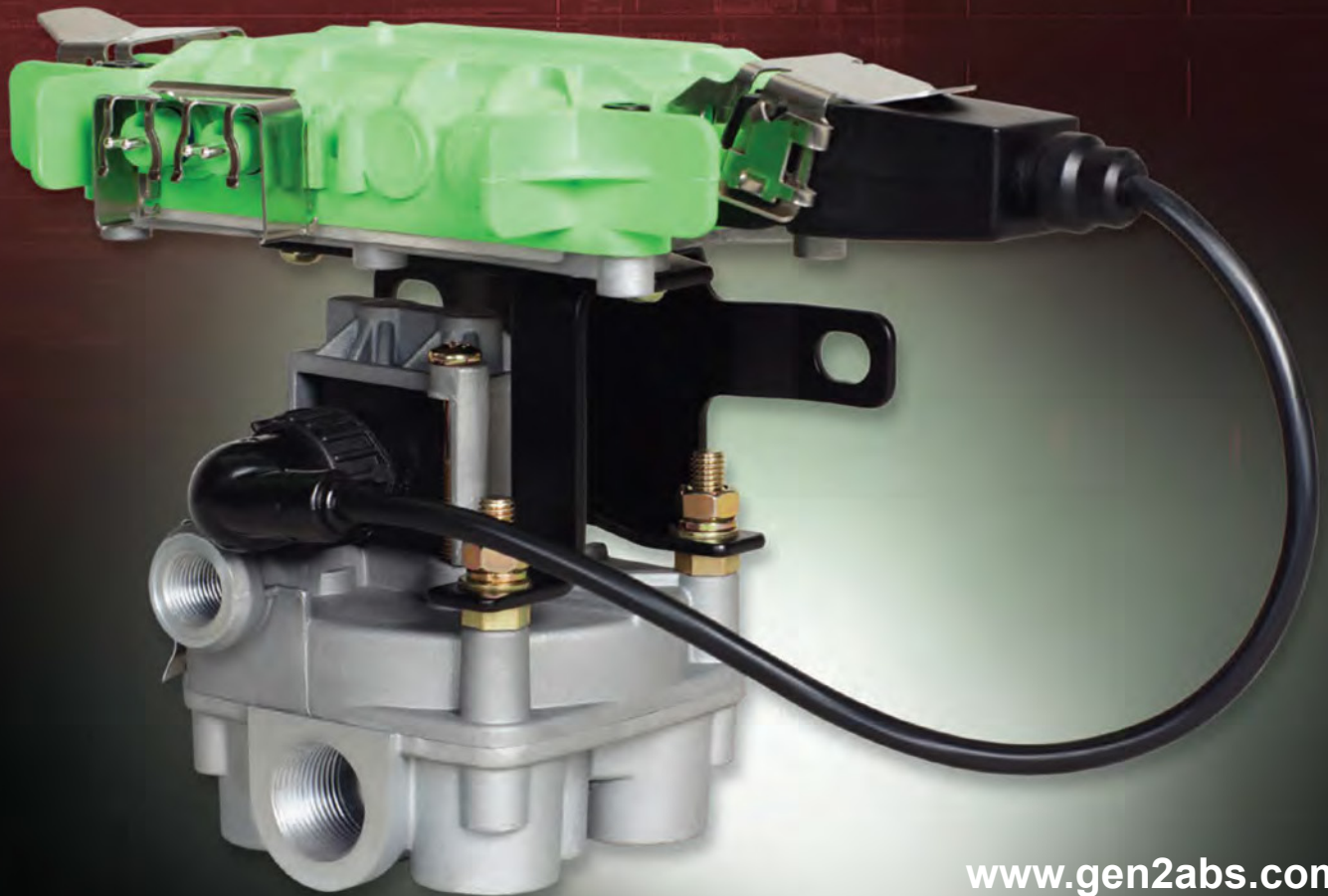

www.gen2abs.com

Smart ECU. Smart Investment.

Trailer monitoring and control is critical for any fleet or vehicle operator on the road today. From safe stopping to rollover prevention to cargo protection and more, the trailer anti-lock braking system (ABS) plays a key role in productivity and uptime. For maximum time on the road, you need a cost-effective ABS solution that's easy to install and maintain while taking advantage of the latest in communications technology. Introducing Gen2 Trailer ABS. Gen2 allows you to quickly and easily replace your existing trailer ABS electronic control unit

(ECU) for unparalleled trailer monitoring and control with more capabilities. Standard ABS ECUs utilize external tools and software for system diagnostics. Gen2 is a SMART ECU that does not require the use of external software for diagnostics and fault codes. By integrating exclusive control logic into the ABS governing hub and information portal, Gen2 allows for highly efficient diagnostic evaluation and dramatically lower cost of operation.



GEN2 ABS 4S/1M

- Connection to all four ports of valve
 - 2 for front axle
 - 2 for rear axle

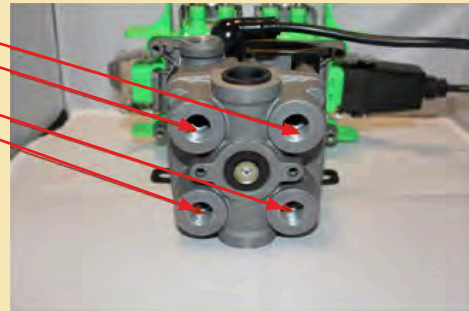
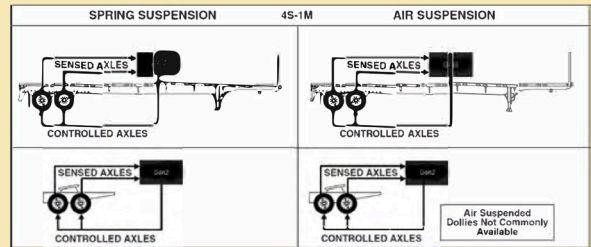

- FASTEST GEN2 SYSTEM
- COST LESS
- SENSES ALL FOUR WHEEL ENDS
- ELIMINATES FLAT SPOTS
- EASIEST DROP IN REPLACEMENT
- TANK MOUNT INSTALLATION

- WEIGHS 3 LBS. LESS
- WIFI DIAGNOSTICS
- OUT PERFORMS WABCO'S ABS CYCLE
- REDUCE INVENTORY
- ONLY ONE VALVE USED FOR 4S OR 2S SYSTEM



WABCO 4S/2M



GEN2 ABS 4S/1M

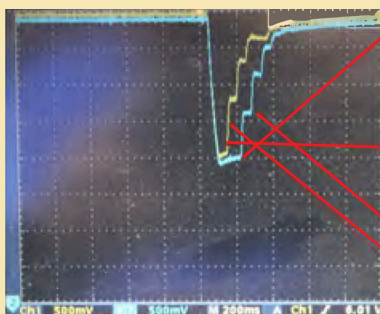

- Exhaust is half of the total exhaust. This equates to release of the tire
- Short width equates to quick stutter of tire break actuation
- Few cycles on build up
- One side is dominant showing an imbalance

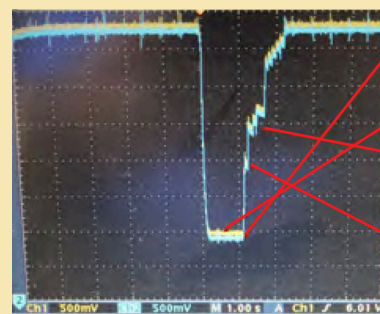

- Exhaust has capability to almost completely release tire
- Burst has greater flexibility to control tire
- Pressure builds up more robust to provide greater control
- Symmetry on both sides provides balance to trailer

WABCO 4S/2M ABS CYCLE VS. GEN2 4S/1M



The First to Offer Intelligent Interface

Gen2 offers revolutionary communication capabilities. It is the first trailer ABS to incorporate a WiFi access point that sends diagnostics to any smartphone or tablet. Now you can receive mobile alerts including the most complete diagnostic information without the need for additional software or diagnostic tools. Future plans for Gen2's intelligent interface include additional monitoring capabilities such as brake and pad wear, tire inflation, trailer tracking and more. All to enhance your condition-based trailer maintenance programs.

Take advantage of the industry-first Gen2 intelligent interface and be at the forefront of innovative trailer ABS diagnostic communications.

System Requirements

Gen2 provides reliable performance day in and day out. Whether you need a 2S/1 M single-channel system or a 4S/2M multi-channel system, we offer the right configuration to meet your trailer needs.

2S/1M Basic

A 2-sensor/1-modulator system offers increased assistance to the driver in maintaining directional stability and control while meeting FMVSS 121 requirements.



ECU Only - WIFI & PLC

GEN2-2010

Includes:

- WiFi & PLC
- Will interchange with Meritor
- ECU to upgrade existing system

2S/1M Kit with PLC

GEN2-1010

Includes:

- ECU: GEN2-2010
- Valve: GEN2-0330
- Modulator Cable: GEN2-2752
- Bracket: GEN2-0584

GEN2-2010

Includes:

- ECU: GEN2-2010
- Valve: GEN2-0330
- Modulator Cable: GEN2-2752
- Bracket: GEN2-0584
- Power Cable: GEN2-3130



intelligent interface



Gen2 Advantages

- ECU can be used on existing Meritor WABCO® ABS platforms
- First to offer WiFi interface
- Does not require costly software and tools to maintain
- Diagnostics can be performed from a smartphone or tablet
- No blink code diagnostics needed
- Approved by major OEM trailer manufacturers

Exceptional Support, Mile After Mile

The Gen2 ECU is covered by a 3-year warranty. All other Gen2 system parts are covered by 1-year standard aftermarket warranty.



GEN2-1031

4S/1 M Kit with PLC & Wifi Replaces 54005001030 Includes: ECU: GEN2-6011 Valve: GEN2-0330

Part Number	Description	Interchange
ABS Components		Replaces Meritor®
ECU ONLY 4S/1 M Kit with PLC & Wifi		
GEN2-2010 *	2S/1M ECU Only (WIFI)	S4008506000/S4461082060
GEN2-6011	4S/1M ECU Only (WIFI)	S4008506010
GEN2-6010	4S/2M ECU Only (WIFI)	S4008506010
FULL ECU/VALVE COMBO/UNIT		
GEN2-1010	2S/1M Valve/ECU (WIFI, No Power Cable)	S4005001010
GEN2-1031 *	4S/1M Valve/ECU (WIFI)	S4005001030
GEN2-1030	4S/2M Valve/ECU (WIFI)	S4005001030
GEN2-0210	2S/1M Kit (Includes GEN2-3120 Cable)	R955344/S4725000210
GEN2-0233	2S/1M Kit Includes GEN2-0100 Power Cable	
GEN2-5374	2s/1m Complete Retrofit Kit, Includes GEN2-1010, GEN2-0470, 2 ea GEN2-0180, 2 ea GEN2-5349	R955374
GEN2-K21220	2S/1M Kit Includes GEN2-0100 and GEN2-0300	Replaces Sealco 21220
BRACKETS		
GEN2-0584	Bracket for 2S/1M	S4784070584
GEN2-0585	Bracket for 4S/2M	
MODULATOR CABLES		
GEN2-2752	Modulator Cable 2S/1M	S894662752
GEN2-2753	Y Modulator Cable for 4S/2M	
VALVES		
GEN2-0330	Valve GEN2-1010/1030/1031	S4721950330/S4008506020
ACCESSORY CABLES		
GEN2-0470	14ft 4 Conductor Power Cable	S4493260470
GEN2-3120	1ft Power Adapter Cable	S8946073120
GEN2-0100	3.3 ft Power Power Cable	S4493260100
GEN2-0101	7.5 Power Cable	
MISC. ACCESSORIES		
GEN2-8154	ABS Sensor Clip	R955458
Meritor WABCO® Style ABS Sensors		Replaces Meritor
GEN2-5349	2 ft Straight	
GEN2-5329	5.6 ft Straight	R955329
GEN2-5337	5.8 ft Straight	R955337
GEN2-5335 *	1 ft 90 degree	R955335
GEN2-5336	3 ft 90 degree	R955336
GEN2-5365	4.6 ft 90 degree	R955365
GEN2-5341	5.8 ft 90 degree	R955341
GEN2-5342	6.6 ft 90 degree	R955342
Bendix® Style ABS Sensors		Replaces Bendix
GEN2-801544	1 ft 90 degree; GDA5801544	801544
GEN2-801545	8.6 ft 90 degree; GDA80145	801545
GEN2-801546	5 ft 90 degree; GDA801545	801546
ABS Extension Cables		Replaces Haldex®/Meritor
GEN2-AL919802	4.9' ABS Extension Cable	AL919802
GEN2-AL919803	6.6' ABS Extension Cable	AL919803
GEN2-AL919806	11.5' ABS Extension Cable	AL919806
GEN2-0180 *	6' ABS Extension Cable	S4497130180
GEN2-0300	10 ft ABS Extension Cable	S4497130300
* (most popular used for OEM builds)		

all references to competitors' part numbers are for cross reference purposes only

ABS SENSOR EXTENSION CABLES

Part Number	Description	Replaces Haldex
GEN2-AL919802	ABS Sensor Extension Cable 4.9' Ft.	AL919802
GEN2-AL919803	ABS Sensor Extension Cable 6.6' Ft.	AL919803
GEN2-AL919806	ABS Sensor Extension Cable 11.5' Ft.	AL919806
GEN2-0180	ABS Sensor Extension Cable 5.8' Ft.	S4497130180
GEN2-0300	ABS Sensor Extension Cable 10' Ft.	S4497130300



ABS SENSOR KITS

Part Number	Description	Harness Length	Replaces
GEN2-5329	Straight	5.6 ft.	R955329
GEN2-5337	Straight	5.8 ft.	R955337
GEN2-5335	90 degree	1 ft.	R955335
GEN2-5336	90 degree	3 ft.	R955336
GEN2-5365	90 degree	4.6 ft.	R955365
GEN2-5341	90 degree	5.8 ft.	R955341
GEN2-5342	90 degree	6.6 ft.	R955342



includes spring clip
GTA-8997598154 & grease
tube

ABS SENSORS

Part Number	Description	Connector Type	Harness Length	Replaces Bendix
GEN2-801544	90 degree	DIN	1 ft.	801544
GEN2-801545	90 degree	Deutsch	8.6 ft.	801545
GEN2-801546	90 degree	Deutsch	5 ft.	801546





Power Cable

GEN2-0470

Easy stop 4 conductor pigtail power cable.

Replaces: S4493260470



Power Adapter Cable

GEN2-3120

Power adapter cable.

Replaces: S8946073120



Modulator Cable Relay

GEN2-2752

Easy stop 4 conductor pigtail power cable.

Replaces: S8946062752



"Y" Modulator Cable

GEN2-2753

"Y" 4S/2M Modulator Cable

Used on Globetech GEN2-1030 4S/2M system



Sensor Clip

GEN2-8154

Sensor clip

Replaces: S8997598154





Spring Brakes

Globetech's Spring Brakes are Assembled in the U.S.A.

- Combination of USA made components and imported components
- Each chamber is assembled in the USA and date coded
- Each component is inspected before assembly



DISCONTINUED

Globetech's Spring Brakes are 100% Tested in the U.S.A.

- Meets all SAE J14659 Air Actuators test procedures
- Cycle life test passed for 1 million cycles on parts side and over 200K on spring side

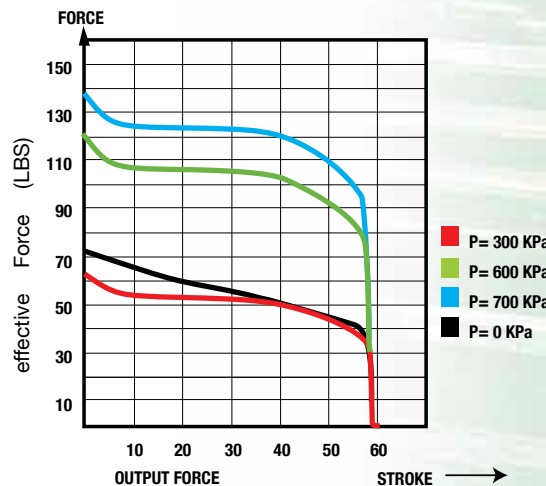

Air Brakes

all references to competitors' part numbers are for cross reference purposes only



AIR BRAKES

Spring Brakes

Renaissance

SERIES

4 YEAR WARRANTY

Technical Information

Power Spring

Black passivated and passes 48 hr salt spray test CNC coiled and meets both force and life cycle requirements as published by Society of Automotive Engineers 1 million cycle test

Non-Pressure Housing

11 Gauge with reinforced mounting bolts to prevent damage Black E-coating and passes 200 hr salt spray test

Clamp Bands

Matched stamping for maximum seal and life High strength steel material consistent long-life pressure Zinc coated and corrosion prevention passes 72 hr salt spray test

Push Rod

Thick steel plate exceeds all OEM standards Rolled edge creates smooth working surface Orange stroke alert indicator OEM CNC welding for push rod/plate attachment (very strong)

Aluminum Adapter

Die cast 360 temp aluminum Double O-Ring Seal Ground/polished push rod for smoothest friction surface

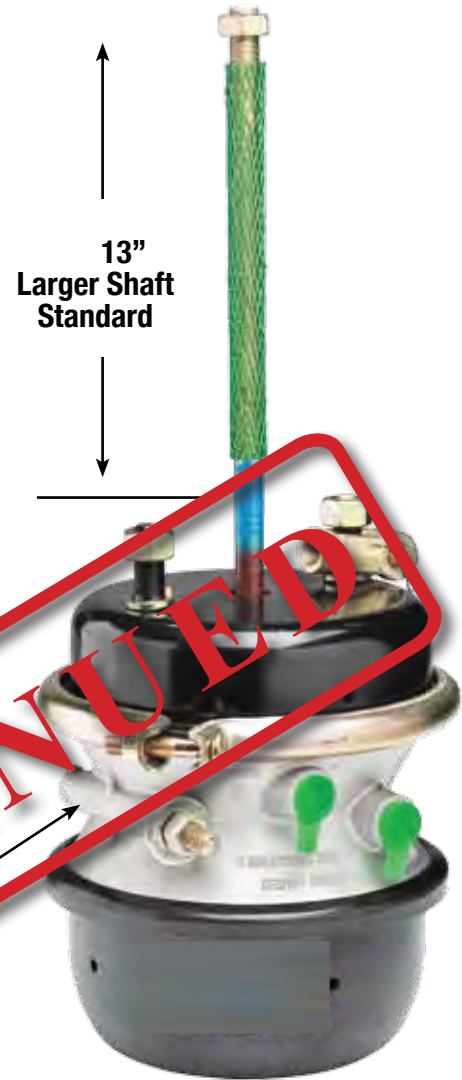

Date Code

Diaphragm

Natural/synthetic rubber blend Meets SAE 1 million cycle test

Return Springs

.177 Spring wire SAE tested to 1 million cycles

Fasteners

All Fasteners are tensile strength and adhere to SAE standards



all references to competitors' part numbers are for cross reference purposes only



Brake Chambers



Part Number	Description OEM	Replaces Ranger
GTA-BC2024	Type 2024 OEM sealed spring brake (Renaissance)	BTS-2024
GTA-BC2424	Type 2424 OEM sealed spring brake (Renaissance)	BTS-2424
GTA-BC2424LS	Type 2424 OEM sealed long stroke spring brake (Renaissance)	BTS-2424LS
GTA-BC2430	Type 2430 OEM sealed spring brake (Renaissance)	BTS-2430
GTA-BC2430LS	Type 2430 OEM sealed long stroke spring brake (Renaissance)	BTS-2430LS
GTA-BC3030	Type 3030 OEM sealed spring brake (Renaissance) USA MADE	BTS-3030
GTA-BC3030LS	Type 3030 OEM sealed long stroke spring brake (Renaissance)	BTS-3030LS
GTA-BC3036	Type 3036 OEM sealed spring brake (Renaissance)	BTS-3036
GTA-BC3636	Type 3636 OEM sealed spring Brake (Renaissance)	BTS-3636
GTA-BC3030-4.5DB	3030 sealed w/ 4.5 rod/dust boot/clevis (Mack)	BTS-3030-4.5 BC
GTA-3030-WCR	Type 3030 welded clevis replacement	3030 WCR
GTA-3030LS-WCR	Type 3030 longstroke welded clevis replacement	3030LS WCR

Value Chamber 100% Tested



Part Number	Description	Aftermarket Series	Replaces Ranger
GTA-BC3030V	Type 3030 valve chamber gold anodized 14" shaft (Economy)		n/a

Piggybacks

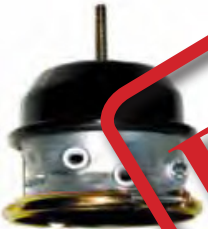

Part Number	Description OEM	Replaces Ranger
GTA-BC3030P	Type 3030 piggyback	BPS-3030
GTA-BC3030PK	Type 3030 piggyback kit w/ 1 diaphragm, 2 clamps, and installation hardware	BPS-3030K
GTA-BC3030PLSK	Type 3030 piggyback long stroke kit	BPS-3030KLS
GTA-BC2024P	Type 2024 Piggyback	BPS-2024
GTA-BC3036P	Type 3036 Piggyback	BPS-3036

Service Chambers



Part Number	Description OEM	Replaces Ranger
GTA-BC36	Type 36 service chamber	BSC-36
GTA-BC30LS	Type 30 service chamber long stroke	BSC-30LS
GTA-BC30SC-WCR	Type 30 service chamber (welded clevis assembly)	30SC-WCR
GTA-BC30	Type 30 service chamber	BSC-30
GTA-BC24	Type 24 service chamber	BSC-24
GTA-BC20	Type 20 service chamber	BSC-20
GTA-BC16	Type 16 service chamber	BSC-16
GTA-BC12	Type 12 service chamber	BSC-12
GTA-BC09	Type 9 service chamber	BSC-09

all references to competitors' part numbers are for cross reference purposes only



AIR BRAKES

Part Number	Description	Replaces Ranger
GTA-30DB	Dust boot	RB-30DB
GTA-006	Type 30 return spring	RB006
GTA-30PS	Type 30 power spring	RB30PS
GTA-009	Carriage bolt&nut 3/8"-16 (Attaches clamps to chamber)	RB009
GTA-010	Jam nut 5/8"-18 (Attaches end of push rod for clevis mount)	RB010
GTA-30DC	Dust caps (black cap that attaches to bottom of chamber)	RB-30DC
GTA-008	T-Bolt Assembly set (1-Washer, T-bolt, T-bolt nut)	RB008
GTA-9PR	T-9 push rod	RB-9PR
GTA-12PR	T-12 push rod	RB-12PR
GTA-16PR	T-16 push rod	RB-16PR
GTA-20PR	T-20 push rod	RB-20PR
GTA-24PR	T-24 push rod	RB033
GTA-30PR	T-30 push rod	RB034
GTA-36PR	T-36 push rod	RB-36PR
GTA-9NPH	T-09 non pressure "stud" housing	RB-9NPH
GTA-12NPH	T-12 non pressure "stud" housing	RB-12NPH
GTA-16NPH	T-16 non pressure "stud" housing	RB-16NPH
GTA-20NPH	T-20 non pressure "stud" housing	RB-20NPH
GTA-24NPH	T-24 non pressure "stud" housing	RB-24NPH
GTA-30NPH	T-30 non pressure "stud" housing	RB020
GTA-36NPH	T-36 non pressure "stud" housing	RB-36NPH

DISCONTINUED



Air Brakes

all references to competitors' part numbers are for cross reference purposes only



Diaphragms Clamps, Clevis Assemblies



- Heavy Duty
 - Reinforced molded sides meets OEM standards
 - Style: clamp ring
- Other styles available by special order

Part Number	Type	Description	Replaces Midland#	Replaces Bendix#	Replaces Ranger
GT-5205	9	Air Brake Diaphragm 5"	KN18090	234425	RB-D-9
GT-5206	16	Air Brake Diaphragm 6"	KN18160	234189	RB-D-16
GT-5208	24	Air Brake Diaphragm 7"	KN18240	234100	RB-D-24
GT-5209	30	Air Brake Diaphragm 8"	KN18300	234100	RB-D-30
GT-5210	30	Air Brake Diaphragm 7-27/32" Long Stroke			RB-D-303
GT-5211	12	Air Brake Diaphragm 5-1/2"	KN18100	234226	RB-D-12
GT-5212	20	Air Brake Diaphragm 6-1/2"	KN18200	234099	RB-D-20
GT-5213	24	Air Brake Diaphragm Long Stroke			RB-D-243
GT-5214	36	Air Brake Diaphragm		234362	RB-D-36

Chamber Clamps



- Black powder coat
- Individual poly bagged
- Type 30 (GT-5280)



Part Number	Type	Description	Replaces Ranger
GTA-5280	30	Steel Chamber Clamp Kit (carriage bolts, nuts, clamps)	RB053
GTA-5281	9	Steel Chamber Clamp Kit (carriage bolts, nuts, clamps)	RB9CK
GTA-5282	12	Steel Chamber Clamp Kit (carriage bolts, nuts, clamps)	RB12CK
GTA-5283	16	Steel Chamber Clamp Kit (carriage bolts, nuts, clamps)	RB16CK
GTA-5284	20	Steel Chamber Clamp Kit (carriage bolts, nuts, clamps)	RB20CK
GTA-5285	24	Steel Chamber Clamp Kit (carriage bolts, nuts, clamps)	RB016
GTA-5286	36	Steel Chamber Clamp Kit (carriage bolts, nuts, clamps)	RB36CK

all references to competitors' part numbers are for cross reference purposes only



Air Colls



AIR-COILS
FIRE & ICE

DISCONTINUED

Withstands temperatures from 212°F (100°C) to -40°

- Coiled, 1/2" O.D. reinforced nylon tubing
- Excellent coil memory and durability
- Color-coded (red - emergency / blue - service) Meets SAE J844 and DOT FMVSS 106 - (49 CFR 571.106 & 49CFR 393.45)
- Designed for 150 psi operating systems
- Resistant to attack by gasoline, diesel fuel, methyl-alcohol and zinc chloride
- Male pipe - brass fittings
- Heavy duty plated spring guards
- D.O.T. fittings



Standard Air Coils DOT FMVSS 106

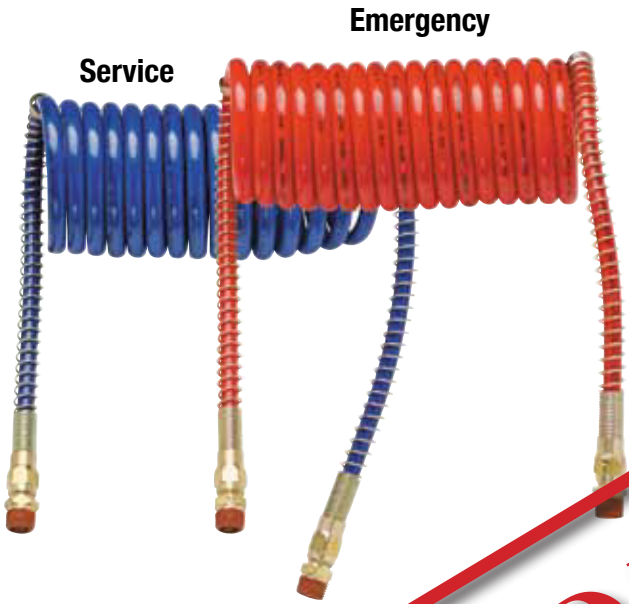

GlobeTech's Air Coils have excellent coil memory



Manufacturer Marking	Hose Type	SAE Tested	Hose Size	D.O.T. Approved	Date Code
↓	↓	↓	↓	↓	↓
GLOBETECH MFG AIR BRAKE SAE J844 1/2 D.O.T. 2011 10 23					

Heavy Duty Air Coils

Part No.	Description	Replaces Tectran	Replaces Phillips
GTA-120606	12" 2 x 06" lead	17212	11-312
GTA-151212	15" 2 x 12" lead	17215	11-315
GTA-151213	15" 1 - 12" lead 1 - 40" lead		11-340
GTA-151214	15" 1 - 12" lead 1 - 48" lead	17215-040	
GTA-201212	20" 2 x 12" lead	17220	11-320

all references to competitors' part numbers are for cross reference purposes only



AIR BRAKES



Xtreme Cold Weather Air Colls GT-151212, GT-151213, GT-151214 Meets DOT FMVSS 106

- Large, 5" coil diameter to improve flexibility
- Pre-applied thread sealant provides air tight seal
- Jacketing provides superior recoil memory. Chemical and abrasion resistance
- Remains flexible to **-85°F** for extreme cold weather protection
- Brass POWER GRIP long brass handle for easy coupling/uncoupling



Long Brass Handle

Xtreme Cold Weather Air Colls

Part No.	Description	Replaces Tectran	Replaces Phillips
GTA-120606X	12" 2 x 06" lead	17B12H	11-5120
GTA-151212X	15" 2 x 12" lead	17B15H	11-5150
GTA-151213X	15" 1 - 12" lead 1 - 40" lead	17B15-40H	11-5400
GTA-151214X	15" 1 - 12" lead 1 - 48" lead	17A15-40H	
GTA-201212X	20" 2 x 12" lead	17B20H	11-5200

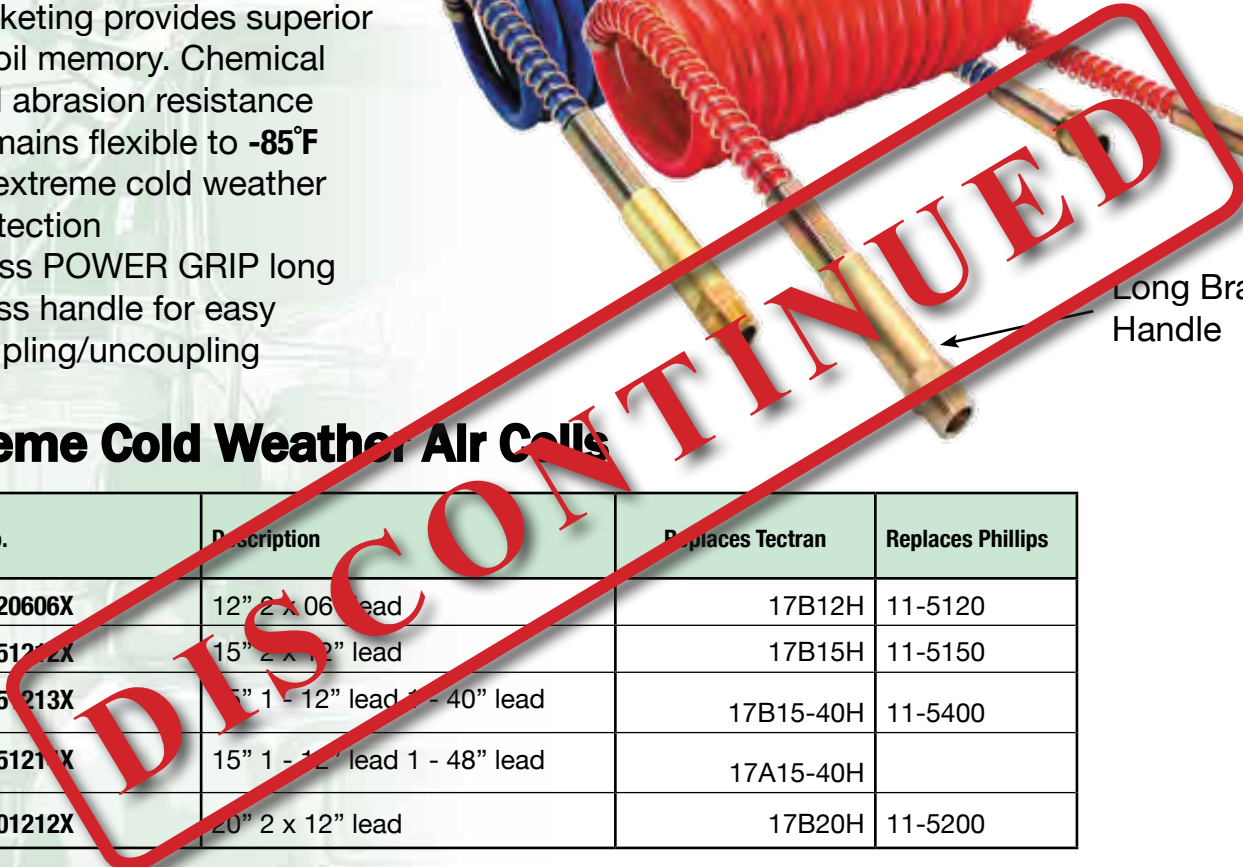

Air Brakes



3 Layer Xtreme Weather Air Colls

- Nylon inner layer reinforced with nylon webbing (1)
- Nylon inner layer (2)
- Urethane outer layer (3)

all references to competitors' part numbers are for cross reference purposes only



Air-Electric 3 to 1 Combo GT-3320

GT-3007 - 7 way OEM Plug
GT-3320 - 15 Ft. 3 to 1 Combo
GT-3321 - 12 Ft. 3 to 1 Combo
GT-3322 - 20 Ft. 3 to 1 combo
GT-3600 - 15 Ft. Spiral Wrap
GT-5341 - Red/Blue Aluminum Hex Grips

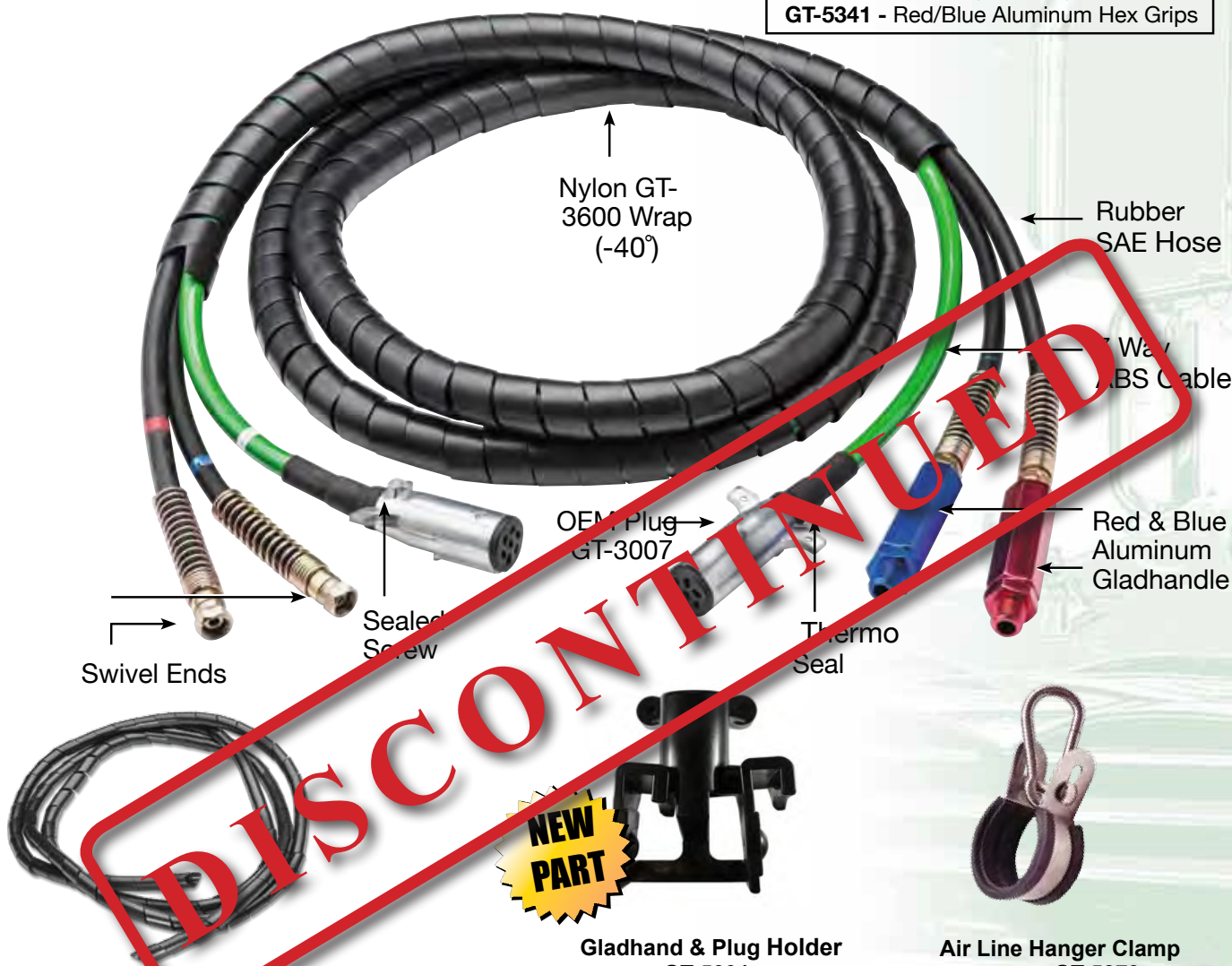

DISCONTINUED

GT-3600 - Spiral Wrap

- 15/ft. long
- Make your own air power assemblies
- Flexible nylon material flexible to -40° F
- U.V. resistant

Replaces
TECTRAN - 832SPR

NEW PART

NEW PART

Air Brakes

all references to competitors' part numbers are for cross reference purposes only



AIR BRAKES

Rubber Air Brake Hose (Bulk)

Manufactured to OEM Specs



Destructive Tests

Destructive tests are conducted on short specimens of hose, normally 18 inches to 36 inches in length and, as the name implies, the hose is destroyed in the performance of the test.

- A. Burst pressure is recorded as the pressure at which actual rupture of a hose occurs.
- B. A hold test, when required, is a means of determining whether weakness will develop under a given pressure for a specified period of time.

Non-Destructive Tests

- a. Proof pressure test
- b. Change in length test (elongation or contraction)
- c. Change in outside diameter or circumference test
- d. Warp test
- e. Rise test
- f. Twist test
- g. Kink test
- h. Volumetric expansion test

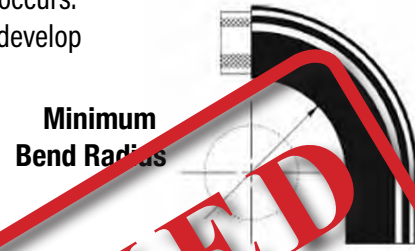

Minimum Hose Bend Radius Data (MBR)

The Bend Radius is the radius of the bent section of a hose measured to the innermost surface of the curved portion. It is important because the minimum bend radius is the maximum amount a hose can be bent without being kinked or damaged.

AIR BRAKE, TYPE A - SAE J1402 & DOT FMVSS 106

Air Brake hose is designed for conveying air in truck and trailer brake systems. Truck and trailer manufacturers, aftermarket installers and wholesalers use this hose. It is certified to meet DOT, FMVSS 106 and SAE J1402A requirements. The EPDM tube and cover with the 4-spiral reinforcement make this hose virtually kink proof. This hose is durable enough to handle this safety related application.



Cover Color:	Black
Oil Resistance:	Medium
Construction:	
Tube:	EPDM, RMA Class C
Cover:	EPDM, RMA Class C
Reinforcement:	Spiral polyester yarn
Temperature Range:	-40°F to +200°F -40°C to +93°C
Packaging:	† Maximum 2 pc. 250 ft. reel, ** 50 ft. length – 1 per carton

Part No.	Nominal I.D. (in)	Nominal O.D. (in)	Working Pressure	Min. Bend Radius (in)	Weight (lb/ft)	Length
GTA-38000	3/8	.75	Min. Burst 900	2.25	0.17	250 ft
GTA-12000	1/2	.88	Min. Burst 900	3.00	0.20	250 ft

all references to competitors' part numbers are for cross reference purposes only



Air Brake Hose Assemblies



- Factory tested to ensure quality
- Meets or exceeds SAE J1402 – Type A
- Meets or exceeds DOT FMVSS No. 106 – Brake Hoses, 49 CFR 571.106
- Available from stock in a wide selection of lengths and end configurations



3/8" Hose, 3/8" Ends			1/2 Hose, 3/8" Ends	
Length	Fixed/Swivel	Swivel/Swivel	Fixed/Swivel	Swivel/Swivel
8	GTA-3838F08	GTA-3838S08	GTA-1238F08	GTA-1238S08
12	GTA-3838F12	GTA-3838S12	GTA-1238F12	GTA-1238S12
14	GTA-3838F14	GTA-3838S14	GTA-1238F14	GTA-1238S14
16	GTA-3838F16	GTA-3838S16	GTA-1238F16	GTA-1238S16
18	GTA-3838F18	GTA-3838S18	GTA-1238F18	GTA-1238S18
20	GTA-3838F20	GTA-3838S20	GTA-1238F20	GTA-1238S20
22	GTA-3838F22	GTA-3838S22	GTA-1238F22	GTA-1238S22
24	GTA-3838F24	GTA-3838S24	GTA-1238F24	GTA-1238S24
26	GTA-3838F26	GTA-3838S26	GTA-1238F26	GTA-1238S26
28	GTA-3838F28	GTA-3838S28	GTA-1238F28	GTA-1238S28
30	GTA-3838F30	GTA-3838S30	GTA-1238F30	GTA-1238S30
32	GTA-3838F32	GTA-3838S32	GTA-1238F32	GTA-1238S32
34	GTA-3838F34	GTA-3838S34	GTA-1238F34	GTA-1238S34
36	GTA-3838F36	GTA-3838S36	GTA-1238F36	GTA-1238S36
38	GTA-3838F38	GTA-3838S38	GTA-1238F38	GTA-1238S38
40	GTA-3838F40	GTA-3838S40	GTA-1238F40	GTA-1238S40
42	GTA-3838F42	GTA-3838S42	GTA-1238F42	GTA-1238S42
44	GTA-3838F44	GTA-3838S44	GTA-1238F44	GTA-1238S44
46	GTA-3838F46	GTA-3838S46	GTA-1238F46	GTA-1238S46
48	GTA-3838F48	GTA-3838S48	GTA-1238F48	GTA-1238S48
50	GTA-3838F50	GTA-3838S50	GTA-1238F50	GTA-1238S50
52	GTA-3838F52	GTA-3838S52	GTA-1238F52	GTA-1238S52
54	GTA-3838F54	GTA-3838S54	GTA-1238F54	GTA-1238S54
56	GTA-3838F56	GTA-3838S56	GTA-1238F56	GTA-1238S56
60	GTA-3838F60	GTA-3838S60	GTA-1238F60	GTA-1238S60
66	GTA-3838F66	GTA-3838S66	GTA-1238F66	GTA-1238S66
72	GTA-3838F72	GTA-3838S72	GTA-1238F72	GTA-1238S72
84	GTA-3838F84	GTA-3838S84	GTA-1238F84	GTA-1238S84



all references to competitors' part numbers are for cross reference purposes only



D.O.T. Reusable Hose Fittings

Male Connector



Part Number	Replaces Tectran	Hose I.D.	Pipe Thread
GTA-105	105	3/8"	1/4"
GTA-106	106	3/8"	3/8"
GTA-107	107	3/8"	1/2"
GTA-106-8	106-8	1/2"	3/8"
GTA-107-8	107-8	1/2"	1/2"

Male Connector Body



Part Number	Replaces Tectran	Hose I.D.	Pipe Thread
GTA-1021	1021	3/8"	1/4"
GTA-1031	1031	3/8"	3/8"
GTA-1041	1041	3/8"	1/2"
GTA-1031-8	1031-8	1/2"	3/8"
GTA-1041-8	1041-8	1/2"	1/2"

Male Connector With Spring Guard



Part Number	Replaces Tectran	Hose I.D.	Pipe Thread
GTA-102	102	3/8"	1/4"
GTA-103	103	3/8"	3/8"
GTA-104	104	3/8"	1/2"
GTA-103-8	103-8	1/2"	3/8"
GTA-104-8	104-8	1/2"	1/2"

Adapter (Swivel Type & Crimped-On Fittings)



Part Number	Replaces Tectran	Pipe Thread	Use On Fitting No.
GTA-161201	161201	1/4"	1105
GTA-161201-6	161201-6	3/8"	1106
GTA-161201-8	161201-8	1/2"	1107
GTA-181201-6	181201-6	3/8"	1106-6
GTA-181201-8	181201-8	1/2"	1107-8

Female Swivel Connector With Adapter



Part Number	Replaces Tectran	Hose I.D.	Pipe Thread
GTA-1105	1105	3/8"	1/4"
GTA-1106	1106	3/8"	3/8"
GTA-1107	1107	3/8"	1/2"
GTA-1106-8	1106-8	1/2"	3/8"
GTA-1107-8	1107-8	1/2"	1/2"

Air Brakes

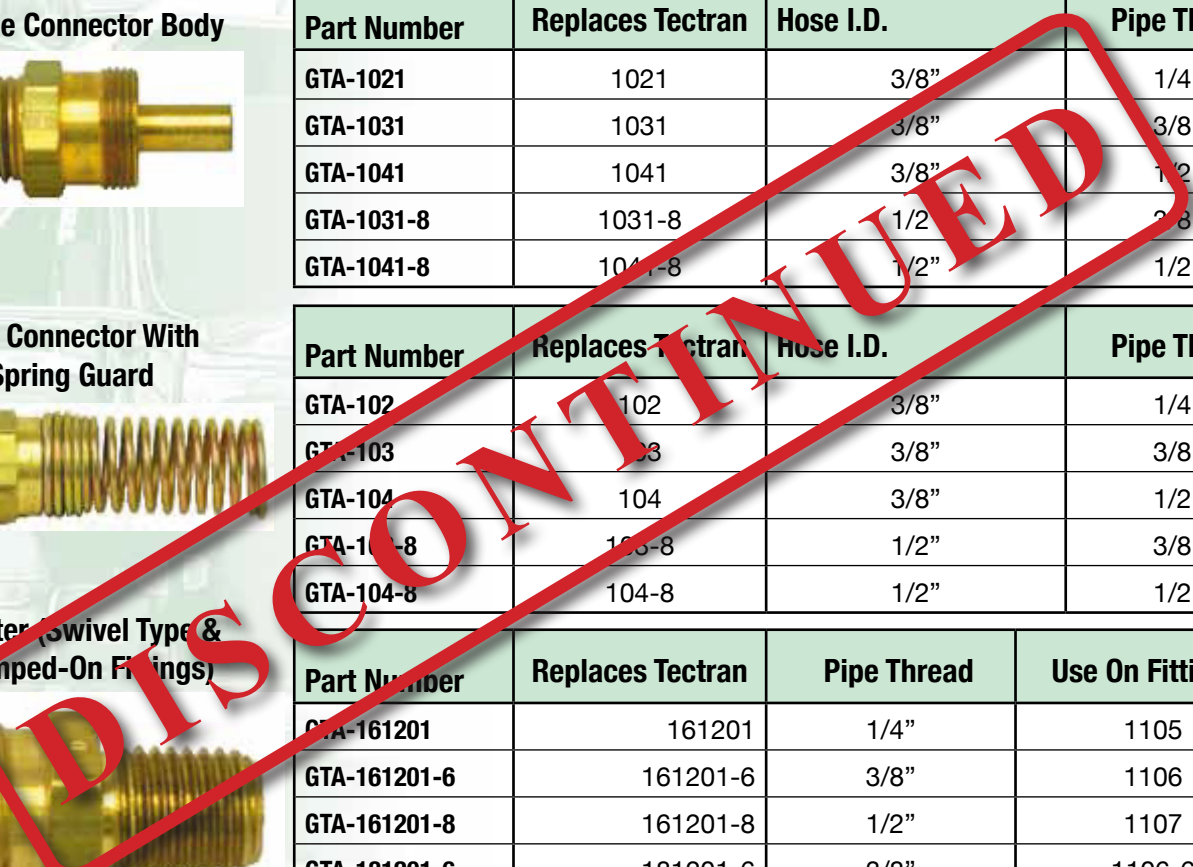

all references to competitors' part numbers are for cross reference purposes only



D.O.T. Reusable Hose Fittings Brass

Ferrule



Part Number	Replaces Tectran	Hose I.D.
GTA-1022	1022	3/8"
GTA-1022-8	1022-8	1/2"

Union



Part Number	Replaces Tectran	Hose I.D.
GTA-105501	105501	3/8"
GTA-107701	107701	1/2"

Union Body



Part Number	Replaces Tectran	Hose I.D.
GTA-1055011	1055011	3/8"
GTA-1077011	1077011	1/2"

Spring Guard



Part Number	Replaces Tectran	Hose I.D.
GTA-1024	1024	3/8"
GTA-1024-8	1024-8	1/2"

Nut With Spring Guard



Part Number	Replaces Tectran	Hose I.D.
GTA-10234	10234	3/8"
GTA-10234-8	10234-8	1/2"

Nut For use with spring guard



Part Number	Replaces Tectran	Hose I.D.
GTA-1023	1023	3/8"
GTA-1023-8	1023-8	1/2"

Hose Nut



Part Number	Replaces Tectran	Hose I.D.
GTA-1025	1025	3/8"
GTA-1025-8	1025-8	1/2"

DISCONTINUED

all references to competitors' part numbers are for cross reference purposes only



AIR BRAKES

Air Brake Nylon Tubing (OEM USE)

- For air brake systems only- NOT for fuel line applications
- SAE Type A tubing is single wall extruded nonreinforced nylon
- SAE Type B tubing has seamless extruded nylon core with fiber reinforced protective nylon cover
- Can be used with either air brake or nylon tube fittings 150 psi maximum working pressure
- UV and ozone resistant nylon material
- Withstands temperatures of -40 to +200 F

Quality Testing Requirements

- Meets or Exceeds SAE J844 type "A" & "B" specifications
- Meets or Exceeds FMVSS 106
- Meets or Exceeds DOT requirements

Part No.	Color	Length	Nominal O.D.	SAE Type
GTA-1922-01	Black	1000' Bulk	1/8"	A
GTA-1922-01-1	Black	100' Coil	1/8"	A
GTA-19225-01	Black	1000' Bulk	5/32"	A
GTA-19225-01-1	Black	100' Coil	5/32"	A
GTA-1923-01	Black	1000' Bulk	3/16"	A
GTA-1923-01-1	Black	100' Coil	3/16"	A
GTA-1924-01	Black	1000' Bulk	1/4"	A
GTA-1924-01-1	Black	100' Coil	1/4"	A
GTA-1924-02	Blue	1000' Bulk	1/4"	A
GTA-1924-02-1	Blue	100' Coil	1/4"	A
GTA-1924-04	Green	1000' Bulk	1/4"	A
GTA-1924-04-1	Green	100' Coil	1/4"	A
GTA-1924-05	Red	1000' Bulk	1/4"	A
GTA-1924-05-1	Red	100' Coil	1/4"	A
GTA-1924-07	Yellow	1000' Bulk	1/4"	A
GTA-1924-07-1	Yellow	100' Coil	1/4"	A
GTA-1926-01	Black	500' Bulk	3/8"	B
GTA-1926-01-1	Black	100' Coil	3/8"	B
GTA-1926-02	Blue	500' Bulk	3/8"	B
GTA-1926-02-1	Blue	100' Coil	3/8"	B
GTA-1926-04	Green	500' Bulk	3/8"	B
GTA-1926-04-1	Green	100' Coil	3/8"	B
GTA-1926-05	Red	500' Bulk	3/8"	B
GTA-1926-05-1	Red	100' Coil	3/8"	B
GTA-1926-07	Yellow	500' Bulk	3/8"	B
GTA-1926-07-1	Yellow	100' Coil	3/8"	B
GTA-1928-01	Black	500' Bulk	1/2"	B
GTA-1928-01-1	Black	100' Coil	1/2"	B
GTA-1928-02	Blue	500' Bulk	1/2"	B
GTA-1928-02-1	Blue	100' Coil	1/2"	B
GTA-1928-05	Red	500' Bulk	1/2"	B
GTA-1928-05-1	Red	100' Coil	1/2"	B
GTA-1928-07	Yellow	500' Bulk	1/2"	B
GTA-1928-07-1	Yellow	100' Coil	1/2"	B
GTA-1930-01	Black	250' Bulk	5/8"	B
GTA-1930-01-1	Black	100' Coil	5/8"	B
GTA-1930-04-1	Green	100' Coil	5/8"	B
GTA-1932-01	Black	250' Bulk	3/4"	B
GTA-1932-01-1	Black	100' Coil	3/4"	B

Type "A"
Single Wall Tubing
1-Layer of Nylon



Type "B" Reinforced
Fiber Wall Tubing 2-Layers of
Nylon



DISCONTINUED

Air Brakes

all references to competitors' part numbers are for cross reference purposes only



Fast Fix Hose Repair Kit



Swivel Hose End Kits

Part Number	Replaces Tectran No.	Thread
GTA-5342	70-31402	3/8" NPTF
GTA-5343	70-31403	1/2" NPTF

Part No.	Hose ID	Pipe Thread	Thread Seal
GT-5342	3/8	3/8	No
GT-5343	3/8	1/2	No

A New Solution for Repairing Damaged Rubber Air Lines



Including

Two nylon shells provide corrosion resistant to improve air system life	One brass fitting with NPTF thread and coating provides tight connection	One assembly ring offers a tight crimping.	One wrench offers a easy installation and reduce residual torque.	One nylon hose barb takes a strong grasp to the rubber hose.

Assembly

Step 1. Cut off the damaged end of the hose. Position hose end on the inside groove of the shell.	Step 2. Insert the brass fitting into the lock shell.	Step 3. Assemble the other side of the shell onto the brass fitting and the hose.	Step 4. Slide the assembly ring over the shell to its final position on the shell.	Step 5. Insert nylon barb into the fitting, turn and push it with the wrench until flush inside the fitting.

Notice:

1. Greasing the nylon barb before inserting it into the fitting.
2. Check final assembly visually to insure that hose has not shifted position during assembly.

Heavy Duty Drain Valve

GT-5300

- 60" cable with 1/4" pipe thread (includes brass valve and cable)
- Replaces Phillips Part No. 12-820

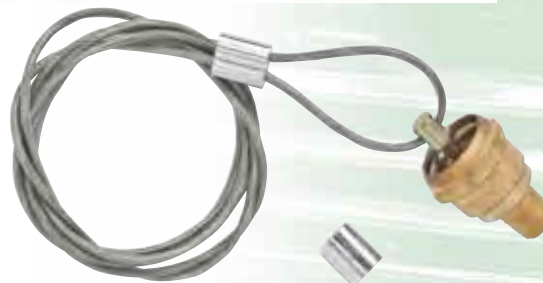

NYLON TUBE CUTTER



GTA-SC1



Part Number	Description	Replaces Tectran
GT-5256	Nylon Tube Cutter	SC-1

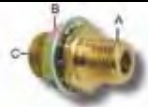

Clamping Studs

Clamping Studs	Part No.	A	B	C	Length	Replaces Sloan	Replaces Tectran	Replaces Tramec
	GT-5251	1/2-14 NPTF	1-14 UNS	1/4-18 NPTF	2-7/8	S600	115-88	50010
	GT-5252	1/2-14 NPTF	1-14 UNS	1/2-14 NPTF	2-3/8	S629		50012
	GT-5253	1/2-14 NPTF	1-14 UNS	3/8-18 NPTF	1-11/16	S620	115-86	50001
	GT-5255	3/8-18 NPTF	1-14 UNS		1-5/16	S607	114-66	50006
	GT-5254	1/4-18 NPTF	3/4-16 UNS		1-1/2	S601	114B-44	50005
	GT-5256	1/2 O.D. Tube	7/8-20 UNF	3/8-18 NPTF	1-5/16	S608	113-8AB	50008
	GT-5257	3/8 O.D. Tube	7/8-20 UNF	3/8-18 NPTF	1-3/8	S609	113-6AB	50009

Slider Bars & Tracker Bar Replacement Parts

- Type 304 stainless steel 3/4" diameter
- Elongated mounting holes cover a range of mounting hole locations

Part No.	A	B	L	Description
GT-5421	20"	10.5"	21.5"	Material: 0.750 Inch O.D. X18GA. 304s.s.Tube
GT-5422	31.5"	22.5"	33.9"	
GT-5423	37.5"	28"	39"	
GT-5424	42.5"	33"	44"	
GT-5425	49.5"	40"	51"	

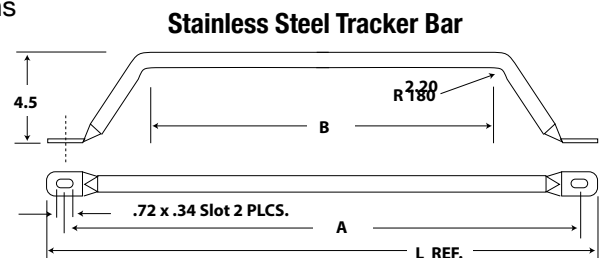

Part Number	Description	Replaces Phillips
GT- 5426	Kit with 39" bar & 20" spring	17-249

- Back of cab cable support
- Kits include bar, snap-on clip, sleeve, 3-hose holder and spring
- Stainless steel bar

all references to competitors' part numbers are for cross reference purposes only



Hose Tender Kits

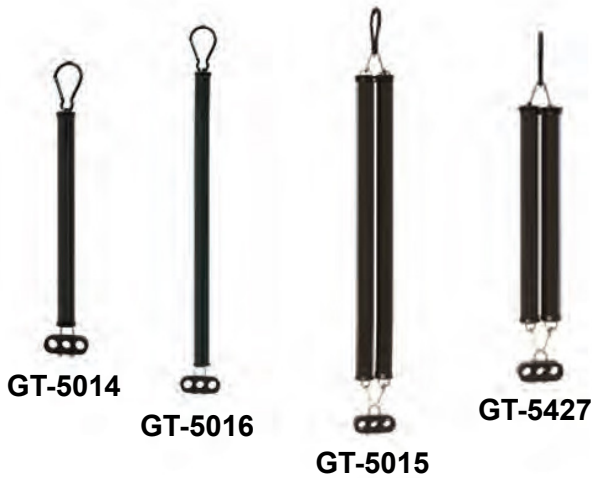

Part Number	Description	Replaces Tectran
GT- 5427	16" Double Spring Tube Holder	9820-2
GT- 5014	16" Single Spring Tube Holder	9820-1
GT- 5015	25" Double Spring Tube Holder	9821-2
GT- 5016	25" Single Spring Tube Holder	9821-1

Each kit is complete with:

- Large snap clip
- Protective sleeve
- Heavy Duty spring
- Hefty clamp hanger
- Slide rings on double kits

Part Number	Description	Replaces Phillips
GT- 5375	Kit with single heavy-duty spring, 20" holder	17-148

- Replacement spring and hardware for tracker bars
- Kits include snap-on clip, sleeve, 3-hose holder and spring (s)
- Ideal for ABS cable use



GT-5375

Part Number	Description	Replaces Tectran
GT-5013	Extreme 3 Hose Holder w/ Eye-bolt/U-Bolt	94001

Part Number	Description	Replaces Phillips
GT- 5007	3" spring with tandem frame clip, 3/4" O.D.	17-103
GT- 5008	6" spring, 1" O.D.	17-106

- For use on trailers with sliding axles
- Supports air lines to rear axle



GT-5013

Part Number	Description	Replaces Phillips
GT- 5001	11" tandem cable and air line support	17-111
GT- 5002	13" tandem cable and air line support	
GT- 5003	16" recommended for straight cable assemblies	17-116
GT- 5004	20" extra heavy-duty, for use with ABS coiled assemblies	17-120
GT- 5006	25", extra heavy-duty, for use with ABS coiled assemblies	17-125

- Pre-galvanized hard drawn wire per SAE-ASTM-A227-77
- All springs are 1" O.D.



all references to competitors' part numbers are for cross reference purposes only



Gladhand & Plug Stow Away Holders



Part Number	Description	Replaces Tectran
GT-5391	Gladhand & Plug Stow Away Holder 1 Slot	9409
GT-5392	Gladhand & Plug Stow Away Holder 2 Slots	9409-2

Hose Separators



- Keeps nylon air hose secure and out of the way
- For 3/8" hose size
- For tractor coiled air, trailer slider hose applications

Part Number	Description	Replaces Phillips
GT-5500-12	2 Hose 1/2" separator	17-150
GT-5500-38	2 Hose 3/8" separator	17-150
GT-5501-12	4 Hose 1/2" separator	17-151
GT-5501-38	4 Hose 3/8" separator	17-151

Hose Holders



Part Number	Description	Replaces Phillips
GT-5001-2	2-Hose holder, .75" hole size	17-156
GT-5001-3	3-Hose holder, .75" hole size	17-157
GT-5001-4	4-Hose holder, .75" hole size	17-158

Slider Hose Undercarriage Tender Kits

- Complete with:
- Beam clip GT-5012
 - Heavy Duty spring
 - 2 or 3-Hole clamp hanger (5001-2, 5001-3)

Part Number	Description
GT-5010	13" Heavy Duty spring with 2-hole clamp
GT-5011	13" Heavy Duty spring with 3-hole clamp



Beam Clip



GT-5012



POGO STICKS

A complete line of Pogo Sticks to fit all needs, no matter what the height requirement is or material.

- Zinc Dichromate
- Chrome
- Stainless Steel (Type 304SS)
- Black Powder-Coated

Zinc Dichromate Pogo Sticks

Part No.	Length	Description	Replaces Tectran
GT-5380	24"	Yellow Zinc	9400D-2
GT-5370	40"	Yellow Zinc	9400E-2
GT-5381	50"	Yellow Zinc	9400L-2

Chrome Pogo Sticks

Part No.	Length	Description	Replaces Tectran
GT-5382	24"	Chrome	9400F-2
GT-5371	40"	Chrome	9400G-2
GT-5383	50"	Chrome	9400M-2

Stainless Steel (Type 304SS) Pogo Sticks

Part No.	Length	Description	Replaces Tectran
GT-5384	24"	Stainless Steel	9400J-2
GT-5385	40"	Stainless Steel	9400H-2

Black Pogo Sticks

Part No.	Length	Description
GT-5372	40"	Black Powder-Coated

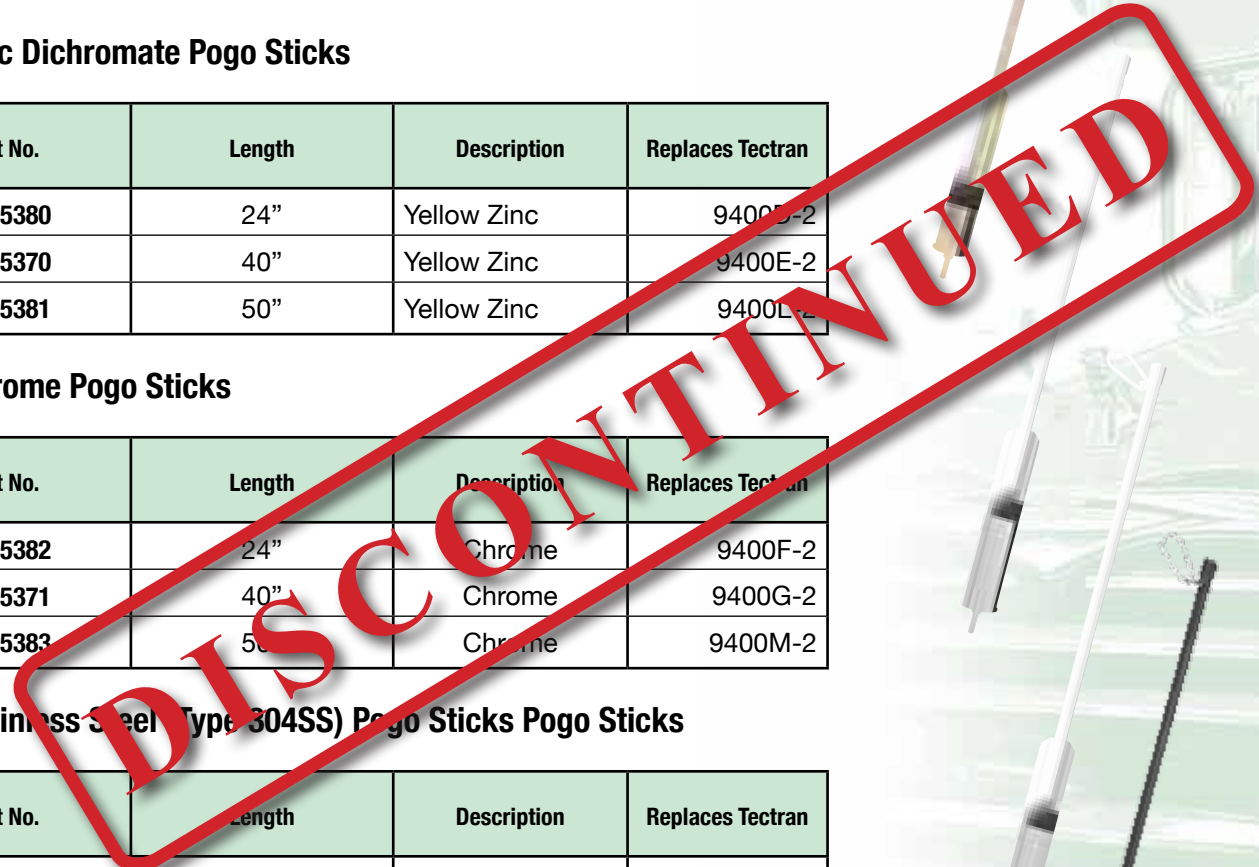

Air Brakes

all references to competitors' part numbers are for cross reference purposes only



AIR BRAKES

OEM Clevis Assemblies

GT-5403

MERITOR STYLE



<u>Thread</u>	<u>Clevis Pin</u>	<u>Pin Dia.</u>	<u>Pack Size</u>
5/8"-18	1/2"	1/4"	4/EA

GT-5404

GUNITE STYLE



<u>Thread</u>	<u>Clevis Pin</u>	<u>Pin Dia.</u>	<u>Pack Size</u>
M 16 X 1.5	12.0 mm	6.0 mm	4/EA

GT-5405

BENDIX STYLE



<u>Thread</u>	<u>Clevis Pin</u>	<u>Pin Dia.</u>	<u>Pack Size</u>
5/8"-18	1/2"	1/4"	4/EA

GT-5406

CREWSON STYLE



<u>Thread</u>	<u>Clevis Pin</u>	<u>Pin Dia.</u>	<u>Pack Size</u>
5/8"-18	1/2"	1/4"	4/EA

DISCONTINUED

Clevis Assembly



**Pack Size
50/EA**

Individual parts for OEM use:

Part #	Thread	Pin	Length	Replaces
GT-5400	5/8"	1/2"	2-3/8"	KN36470
GT-5401	1/2"	1/2"	2-3/8"	
GT-5402	5/8"	5/8"	2-3/8"	
Part #	Description			
GT-5400A	clevis yoke 5/8", replacement yoke for GT-5400			
GT-5400B	clevis pin 1/2", replacement yoke for GT-5400			
GT-5400C	cotter pin, fits all available clevis pins			
GT-5402A	clevis yoke 1/2", replacement yoke for GT-5402			
GT-5402B	clevis pin 5/8", replacement pin for GT-5402			

all references to competitors' part numbers are for cross reference purposes only



Selecting a Slack Adjuster

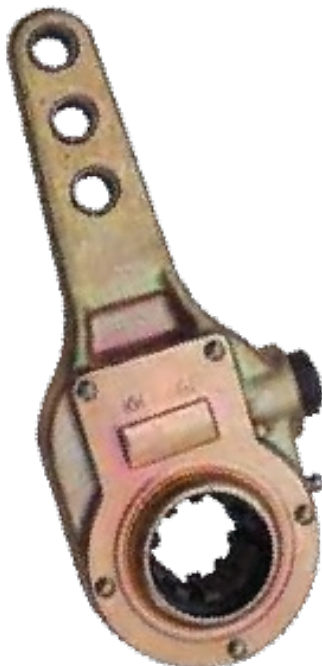

1. Determine if straight or offset arm. If offset determine if RH or LH needed.
2. Identify spline size (diameter and number of teeth).
3. Select model needed.
4. Determine the arm hole used (if slack contains more than one).
5. Identify bushing diameter.
6. Measure from center of arm hole used to center of splined hole to determine arm length (A).

All Globetech slacks meet the following criteria:

TS16949 Certified
 Meet SAE J1461-91 &
 SAE J1512-90 Standards
 Torque Rating:
 20,000 - 26,000 inch lbs. or
 2,300 - 3,000 Newton
 Meter
 Life time: More than
 200,000 cycles

Manual Straight Arm Slack Adjuster Without Clevis

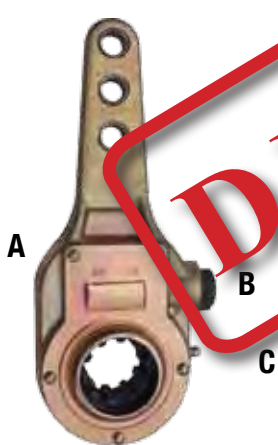
	Part Number	Spline	A	B	C	Replaces
	GTA-KN44051	1-1/2" - 28	5"	6"		Batco 05-328 Bendex BWP M-638 Euclid Leland Meritor Midland Norforge Spicer Sirco S2011A
	GTA-KN44071	1-1/2" - 28	5"	6"	7"	Batco Bendex 286965 BWP M-3373 Euclid E-2458S Leland L-1308EC Meritor R824003 Midland KN44071 Norforge A-7085 Spicer 10-355 Sirco S2022A

all references to competitors' part numbers are for cross reference purposes only



AIR BRAKES

Manual Straight Arm Slack Adjusters Without Clevis

	Part Number	Spline	A	B	C	Replaces	
	GTA-KN44061	1-1/2" - 28	5-1/2"	6-1/2"		Batco 05-237 Bendex 288753 BWP M-2577 Euclid E-2459S Leland L-1648EC Meritor R824004 Midland KN44051 Norforge A-7094 Spicer 10-368 Sirco S2019A	
	GTA-KN51010	1-1/2" - 28	6"			Batco 05-251 Bendex BWP M-3374 Euclid E-2498 Leland L-2349 Meritor R8275J686 Midland KN51010 Norforge A-7228 Spicer Sirco S2023	
			Curved Arm For 1-1/4" "Q" Brackets				
	GTA-KN44041	1-1/2" - 35	6"			Batco 05-240 Bendex 283411 BWP M-474 Euclid E-1574S Leland L-841EC Meritor R824007 Midland KN44041 Norforge A-7100 Spicer 10-367 Sirco S2012A	
	GTA-KN48031	1-1/4" - 10	4-1/2"	5-1/2"		Batco 05-214 Bendex 278302 BWP M-3375 Euclid E-4904 Leland L-2494 Meritor R822009 Midland KN8031 Norforge A-7134 Spicer 10-399 Sirco S2026	
			For all 1-1/4" - 10 Spline Camshafts				

DISCONTINUED

Air Brakes

all references to competitors' part numbers are for cross reference purposes only



Manual Slack Adjusters

- Zinc-Dichromate Finish
- Positive Locking Adjustment
- Heat Treated Alloy Gears
- Threaded Grease Fitting
- Bi-Directional Body Design

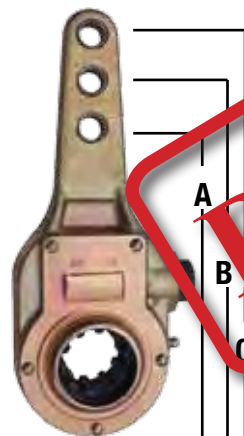
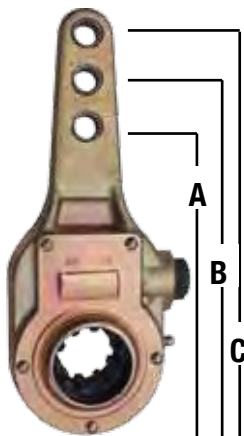

Part Number	Spline	A	B	C	Replaces
GTA-KN55001	1-1/4" - 24	5-1/2"			Batco 05-254 Bendex BWP M-3984 Euclid E-9102 Leland L-3225 Meritor R825020 Midland KN55001 Norforge Spicer Sirco S2024 For Meritor 15" x 4" "Q" Brakes
GTA-KN47081	1-1/2" - 10	5"	6"		Batco Bendex 278010 BWP M-452 Euclid E-1063HD Leland L-562 Meritor R823000 Midland KN47081 Norforge A-7022 Spicer M16WR105 Sirco S2021A
GTA-KN47001	1-1/2" - 10	5"	6"		Batco Bendex 278010 BWP M-452 Euclid E-1063HD Leland L-562 Meritor R823000 Midland KN47081 Norforge A-7022 Spicer M16WR105 Sirco S2010A
GTA-KN47011	1-1/2" - 10	5-1/2"	6-1/2"		Batco 05-201 Bendex 278321 BWP M-457 Euclid E-940BK Leland L-845EC Meritor R824001 Midland KN47011 Norforge A-7044 Spicer 10-354 Sirco S2020A
GTA-KN51000	1-1/2" - 10	6"			Batco 05-250 Bendex 278084 BWP M-475 Euclid E-2091 Leland L-1275 Meritor Midland KN51000 Norforge A7225 Spicer M12WR101 Sirco S2025 Curved Arm For 12-1/4" Brakes

DISCONTINUED

all references to competitors' part numbers are for cross reference purposes only



Automatic Slack Adjusters



Part Number	Spline	Arm Length	Replaces
GTA-065164	1-1/4" - 10	5-1/2"	Bendex 065164 Gunite AS1136/ AS1152 Midland CS56036 Sirco SA2164
GTA-065167	1-1/4" - 24	5-1/2"	Bendex 065167 Gunite AS1138/ AS1154 Midland CS56038 Sirco SA2167
GTA-065170	1-1/2" - 10	5-1/2"	Bendex 065170 Gunite AS1132/ AS1147 Midland CS56032 Sirco SA2170
GTA-065172	1-1/2" - 10	5-1/2"	Bendex 065172 Gunite AS1133/ AS1146 Midland CS56033 Sirco SA2172
GTA-065174	1-1/2" - 28	5-1/2"	Bendex 065174 Gunite AS1140/ AS1149 Midland CS56040 Sirco SA2174
GTA-065175	1-1/2" - 28	6"	Bendex 065175 Gunite AS1141/ AS1151 Midland CS56041 Sirco SA2175
GTA-065178	1-5/8" - 37	5-1/2"	Bendex 065178 Gunite Midland CS56043 Sirco SA2178
GTA-065179	1-5/8" - 37	6"	Bendex 065179 Gunite AS1144 Midland CS56044 Sirco SA2179
GTA-R801073	28 DIA. 1-1/2"	Drillings 5.5"	Meritor R801073
GTA-R801074	28 DIA. 1-1/2"	Drillings 6"	Meritor R801074

DISCONTINUED

Air Brakes

all references to competitors' part numbers are for cross reference purposes only



Automatic Slack Adjusters

	Part Number	Spline	A	B	C	Replaces
	GTA-40010144	1-1/2" - 28	6"			Batco Bendex BWP Euclid E-6918A Leland Meritor R806016 Midland 40010144 Norforge Spicer Sirco SA10144
	GTA-40010142	1-1/2" -10		5" - 6"		Batco Bendex BWP Euclid E-6913B Leland Meritor R806023 Midland 40019142 Norforge Spicer Sirco SA10102
	GTA-40010143	1-1/2" -10	5-1/2" - 6-1/2"			Batco Bendex BWP Euclid E-6924B Leland Meritor R806022 Midland Norforge Spicer Sirco SA10103
	GTA-40010145	1-1/2" -28	5" - 6"			Batco Bendex BWP Euclid E-6925B Leland Meritor R806024 Midland Norforge Spicer Sirco SA10100

DISCONTINUED

all references to competitors' part numbers are for cross reference purposes only



AIR BRAKES

Automatic Brake Adjusters

	Part Number	Spline	Arm Length	Replaces
	GTA-40010141	1-1/2" - 28	5-1/2" - 6-1/2"	Batco Bendex BWP Euclid E-6927B Leland Meritor R806004/26 Midland 40010141 Norforge Spicer Sirco SA10101
			For Standard Drive Axle Brakes	
	GTA-40010306	1-1/2" - 10	6"	Batco Bendex BWP Euclid E-6928 Leland Meritor R806007 Midland 40010306 Norforge Spicer Sirco SA10306
			For 12-1/4" Trailer Axle Brakes	
	GTA-40010305	1-1/2" - 28	6"	Batco Bendex BWP Euclid E-6933 Leland Meritor R806006 Midland 40010305 Norforge Spicer Sirco SA10305
			For 12-1/4" Trailer Axle Brakes	
	GTA-40010215	1-1/2" - 10	5-1/2"	Batco Bendex BWP Euclid E-6940 Leland Meritor R806021 Midland 40010215 Norforge Spicer Sirco SA10215
			For 16-1/2" Trailer Axle Brakes	
	GTA-40010216	1-1/2" - 10	6"	Batco Bendex BWP Euclid E-6936 Leland Meritor R806015 Midland 40010216 Norforge Spicer Sirco SA10216
			For 16-1/2" Trailer Axle Brakes	

DISCONTINUED

Air Brakes

all references to competitors' part numbers are for cross reference purposes only



Automatic Brake Adjusters

	Part Number	Spline	Arm Length	Replaces
	GTA-40010211	1-1/2" - 28	5-1/2"	Batco Bendex BWP Euclid E-6944 Leland Meritor R806019 Midland 40010211 Norforge Spicer Sirco SA10211
		For 16-1/2" Trailer Axle Brakes		
	GTA-40010212	1-1/2" - 28	6"	Batco Bendex BWP Euclid E-6942 Leland Meritor R806013 Midland 40010212 Norforge Spicer Sirco SA10212
		For 16-1/2" Trailer Axle Brakes		
	GTA-40010214	1-5/8" - 28	6"	Batco Bendex BWP Euclid E-6946 Leland Meritor R806014 Midland 40010214 Norforge Spicer Sirco SA10214
		For 16-1/2" Fruehauf Trailer Axle Brakes		

DISCONTINUED

Globetech Slack Adjusters are manufactured to OEM standards Automatic Slack Adjusters available to replace: Crewson, Bendix, Haldex and Meritor

all references to competitors' part numbers are for cross reference purposes only



AIR BRAKES

Crewson Style Standard Automatic Slack Adjusters

Part No.	Replaces Crewson	Chamber Size	Spline Size	Clevis	Arm Length
GTA-21102	21102	ALL	1-1/2"-10	5/8"-18 STR	5.5, 6.5
GTA-21103	21103	ALL	1-1/2"-10	5/8"-18 STR	5.0, 6.0
GTA-22102	22102	ALL	1-1/2"-28	5/8"-18 STR	5.5, 6.5
GTA-22103	22103	ALL	1-1/2"-28	5/8"-18 STR	5.0, 6.0
GTA-23102	23102	ALL	1-5/8"-37	5/8"-18 STR	5.5, 6.5
GTA-24100	24100	ALL	1-1/4"-10	5/8"-18 STR	5.5, 6.5
GTA-24102	24102	ALL	1-1/4"-10	5/8"-18 STR	5.5, 6.5
GTA-24103	24103	ALL	1-1/4"-10	5/8"-18 STR	5.0
GTA-25100	25100	ALL	1-1/4"-10	5/8"-18 STR	5.5
GTA-25102	25102	ALL	1-1/4"-24	5/8"-18 STR	5.5, 6.5
GTA-25103	25103	ALL	1-1/4"-24	5/8"-18 STR	5.0, 6.0



Crewson Style Auto-Check Slack Adjusters

Part No.	Replaces Crewson	Chamber Size	Spline Size	Clevis	Arm Length
GTA-34100	34100	20/24	1-1/2"-10	5/8"-18 STR	5.5
GTA-34200	34200	16	1-1/4"-10	1/2"-20 STR	5.5
GTA-35100	35100	20/24	1-1/4"-24	5/8"-18 STR	5.5
GTA-35200	35200	16	1-1/4"-24	1/2"-20 STR	5.5
GTA-41100	41100	30	1-1/2"-10	5/8"-18 STR	5.5
GTA-41106	41106	30	1-1/2"-10	5/8"-18 STR	6.0
GTA-42100	42100	30	1-1/2"-28	5/8"-18 STR	5.5
GTA-42106	42106	30	1-1/2"-28	5/8"-18 STR	6.0
GTA-43100	43100	30	1-5/8"-37	5/8"-18 STR	5.5
GTA-43106	43106	30	1-5/8"-37	5/8"-18 STR	6.0

The auto-check stroke indicator attaches to the automatic brake adjuster; which eliminates the need to crawl under vehicles to determine air chamber stroke. Not interchangeable with other slack adjusters.

Air Brakes

all references to competitors' part numbers are for cross reference purposes only



Slack Adjuster Cross Reference

HalDEX/Midland	Manual Globetech	Page No.	Automatic Bendix	Globetech	Page No.
KN44041	GTA-44041	106	065164	GTA-065164	111
KN44051	GTA-44051	105	065167	GTA-065167	111
KN44061	GTA-44061	106	065170	GTA-065170	111
KN44071	GTA-44071	105	065172	GTA-065172	111
KN47001	GTA-47001	107	065174	GTA-065174	111
KN47011	GTA-47011	107	065175	GTA-065175	111
KN47081	GTA-47081	107	065178	GTA-065178	111
KN48031	GTA-48031	106	065179	GTA-065179	111
KN51000	GTA-51000	108	Meritor	Globetech	Page No.
KN51010	GTA-51010	106	R801073	GTA-R801073	111
KN55001	GTA-55001	107	R801074	GTA-R801074	111
HalDEX/Midland	Automatic Globetech	Page No.	Crowson	Globetech	Page No.
			21102	GTA-21102	112
40010140	GTA-40010140	108	21103	GTA-21103	112
40010141	GTA-40010141	109	22102	GTA-22102	112
40010142	GTA-40010142	108	22103	GTA-22103	112
40010143	GTA-40010143	108	23102	GTA-23102	112
40010144	GTA-40010144	108	24100	GTA-24100	112
40010211	GTA-40010211	110	24102	GTA-24102	112
40010212	GTA-40010212	110	24103	GTA-24103	112
40010214	GTA-40010214	110	25100	GTA-25100	112
40010215	GTA-40010215	109	25102	GTA-25102	112
40010216	GTA-40010216	109	25103	GTA-25103	112
40010305	GTA-40010305	109	34100	GTA-34100	112
40010306	GTA-40010306	109	34200	GTA-34200	112
			35100	GTA-35100	112
			35200	GTA-35200	112
			41100	GTA-41100	112
			43106	GTA-41106	112

DISCONTINUED

Parts listed in this catalog are not necessarily manufactured by the original equipment manufacturer and any reference to the trademarks or part numbers of others are for cross reference informational purposes only. The photos provided herein are provided only for illustrative purposes. The actual products supplied may differ. The trademarks of others referred to herein are owned by their respective companies and are not affiliated in any way with Globetech Manufacturing Inc. No representation is made with respect to the source of manufacturer of any particular part. While every efforts is made to provide accurate information, no guarantee is provided as to the accuracy of the information contained herein. We are not responsible for typographical errors.

all references to competitors' part numbers are for cross reference purposes only



Valve Index

Bendix	Globetech	Haldex	Globetech
284412 (DV-2)	GTA-284412	KN16743	GTA-16743
277863 (E-3)	GTA-277863	KN23000	GTA-23000
286171 (E-6)	GTA-286171	KN20030	GTA-20030
286773 (E-7)	GTA-283773	KN20031	GTA-20031
280479 (DC-1)	GTA-280479	KN28600 (FF-2)	GTA-28600
278414 (DC-4)	GTA-278414	KN28601 (FF-2)	GTA-28601
278415 (DC-4)	GTA-278415	KN20541	GTA-20541
276566 (PP-1)	GTA-276566	KN26000	GTA-26000
276567 (PP-1)	GTA-276567	KN27000	GTA-27000
280479 (DC-1)	GTA-280479	KN3546	GTA-3546
229635	GTA-229635	KN28500	GTA-28500
275491 (D-2)	GTA-G8602	KN28510	GTA-28510
279472 (LP-3)	GTA-279472	KN28520	GTA-28520
228750 (LP-3)	GTA-228750	KN30300	GTA-30300
288239 (PP-7)	GTA-288239	KN30400	GTA-30400
065066 (QR-N)	GTA-065066	KN4688	GTA-4688
065067 (QR-N)	GTA-065067	Neway	Globetech
229859 (QR-1A)	GTA-229859	K91005	GTA-910058
229860 (QR-1B)	GTA-229860	90054007	GTA-90054007
289714 (QR-1C)	GTA-289714	90554241	GTA-90554241
289182 (QR-1C)	GTA-289182	90554243	GTA-90554243
065104 (R-12)	GTA-065104	90054079	GTA-90054079
102626 (R-12)	GTA-102626	90054088	GTA-90054088
103009 (R-12)	GTA-103009	90054107	GTA-90054107
103028 (R-14)	GTA-103028	90054074	GTA-90054074
103010 (R-14)	GTA-103010	90054075	GTA-90054075
281865 (RE-6)	GTA-281865	90054076	GTA-90054076
065145 (BP-RI)	GTA-065145	Sealco	Globetech
065146 (BP-RI)	GTA-065146	110500	X-5
286370 (R-8)	GTA-286370	110700	GTA-110700
131081 (SI-4)	GTA-131081	110800	GTA-110800
284143 (ST-3)	GTA-284143	17600B	GTA-17600
205105 (ST-1)	GTA-205105	110170	GTA-110170
065437 (SR-5)	GTA-065437	110171	GTA-110171
065439 (SR-5)	GTA-065439	140280	GTA-140280
102761 (SR-2)	GTA-102761	140270	GTA-140270
228600 (SL-4)	GTA-228600	996555	GTA-996555
101112 (SR-4)	GTA-101112	110415	GTA-110415
101622 (SR-4)	GTA-101622	110380	GTA-110380
279000 (TP-3)	GTA-279000	110197	GTA-110197
Fuller	Globetech	110139	GTA-110139
A-470	GTA-A-470	110410	GTA-110410
A-5000	GTA-A-5000	21600	GTA-21600
Midland	Globetech	110515	GTA-110515
12353	GTA-12352	616	GTA-616
		110191	GTA-110191
		17600B-1	GTA-17600B-1
		110376	GTA-110376
		110205	GTA-110205
		2550	GTA-2550

DISCONTINUED

Air Brakes

all references to competitors' part numbers are for cross reference purposes only



Air Regulator Valves



All ports: 1/8" NPT
Non-adjustable preset
at 57-65 PSI Replaces:
Haldex KN16743

Part Number	Description
GTA-16743	Oil regulator valve

Automatic Reservoir Drain Valves

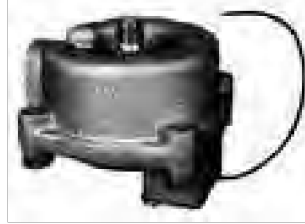

Overall height: 2-3/8"
Overall width: 3-3/4"
Port A: 3/8" PT
Port B: 3/8" PT
Adapter: 1/4" PT
Replaces: Bendix 284412 (DV-2)

Part Number	Description
GTA-284412	Automatic reservoir drain valve

Brake Valves



Overall height: 4-5/16"
Delivery Ports: (4) 1/2" PT
Auxiliary Ports: none
Replaces: Bendix 277863 (E-3)

Part Number	Description
GTA-277863	Brake valve (basic)



Overall height: 5-5/8"
Supply Ports: (2) 3/8" PT
Delivery Ports: (2) 3/8" PT
Exhaust at bottom
Replaces: Bendix 286171 (E-6)

Part Number	Description
GTA-286171	Dual brake valve with pedal



Overall height: 5-1/16"
Rear ports: (4) 1/2"
Side Ports: (8) 1/4"
Mounting Studs: (3) 1-1/2" L
Replaces: Bendix 286773 (E-7)

Part Number	Description
GTA-286773*	Dual brake valve (basic) 3 mounting bolts installed
GTA-286771	Dual brake valve (basic)

CAB Control Valves



Delivery Port: 1/4" NPT
Supply Port: 1/4" NPT
Exhaust Port: 1/4" non-threaded
Push/pull, hand control
Knob/name plate not included
Replaces: Sealco 17600

Part Number	Description
GTA-17600	CAB control valve

all references to competitors' part numbers
are for cross reference purposes only



AIR BRAKES

Check Valves & Control Valves



Length: 2.47" Inlet/
Outlet: 1/2" Style:
Heavy Duty
Replaces: Haldex
KN23000

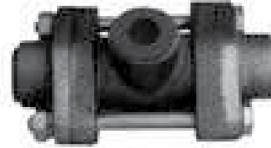

3 ports: Pipe thread dimension
3/8" (all ports)
Replaces: Bendix 280479
(DC-1)

Part Number	Description
GTA-23000	Single check valve, 1/2"
GTA-23800	Single check valve, 3/8"

Part Number	Description
GTA-280479	Double check valve



GTA-278614: 3 ports, pipe
thread dimension 3/8"
Replaces: Bendix 278614
(DC-4) GTA-278615: 3 ports,
pipe thread dimension 1/4"
Replaces: Bendix 278615
(DC-4)



Body height: 2-1/2"
Delivery ports: (2) 1/8" PT
Supply ports: (1) 1/8" PT Lever:
Steel with Chrome Finish
Replaces: Bendix 229635

Part Number	Description
GTA-278614	Double check valve
GTA-278615	Double check valve

Part Number	Description
GTA-229635	Control valve



Overall height: 3-19/32" Delivery
ports: (2) 1/8" PT Supply ports:
(1) 1/8" PT Automatic Release
Pressure: GTA-276566 20 PSI
GTA-276567 40 PSI
Replaces: Bendix 276566 (PP-1)
Bendix 276567 (PP-1)

Part Number	Description
GTA-276566	Control valve
GTA-276567	Control valve

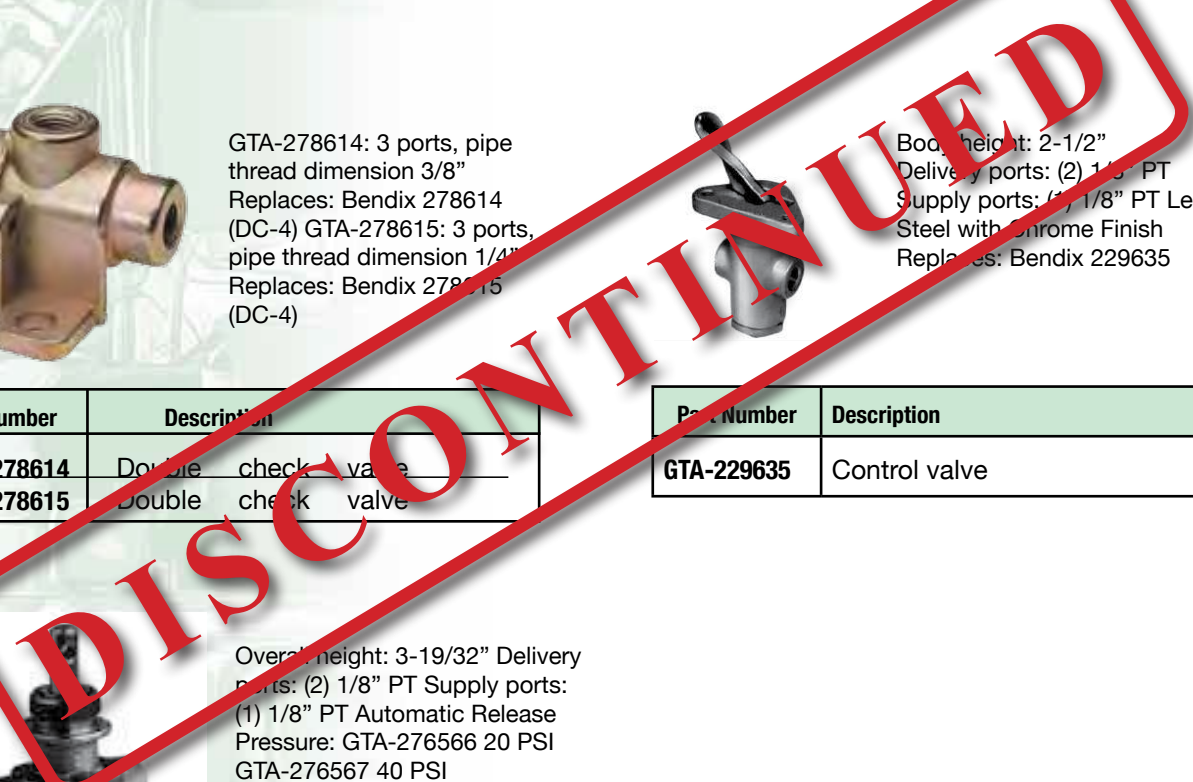



Check Valves & Control Valves



Push/pull, hand operated
 Delivery port: 1/4"
 Supply port: 1/4"
 Exhaust port: 1/4" non threaded
 Replaces: Haldex KN20030
 KN20031



Part Number	Description
GTA-20030	Dash control valve
GTA-20031	Dash control valve

Part Number	Description
GTA-M7102	Dash control valve
GTA-M7102-K	Knobs only

Filter Assemblies

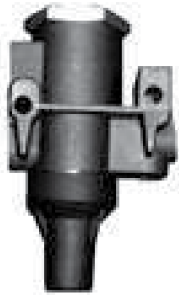

All ports: 1/8" NPT
 Non-adjustable
 Preset at 57-65 PSI
 Replaces: Fuller A-4740

Part Number	Description
GTA-A4740	Filter assembly

Full Function Valves



Spring brake ports: (2) 3/8"
 Service brake ports: (4) 3/8"
 Supply ports: (1) 3/8"
 Control ports: (1) 1/4"
 Reservoir ports: (1) GTA-28600 3/4"
 GTA-28601 1/2"
 Crack Pressure: 3 PSI
 Replaces: Haldex KN28600 (FF-2)
 KN28601 (FF-2)

Part Number	Description
GTA-28600	Full function valve
GTA-28601	Full function valve

Governors

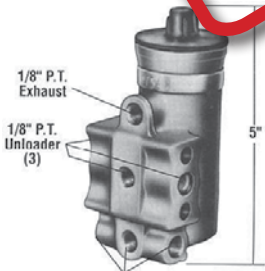

Pressure: 100-120
 PSI, non-adjustable
 Replaces: Bendix 275491 (D-2)

Part Number	Description
GTA-G8602	Governor

Hand Control Valves



Delivery Port: 1/4"
 Supply Port: 1/4"
 Control Port: 1/4"
 Replaces: Haldex KN20541

Part Number	Description
GTA-20541	Hand control valve

all references to competitors' part numbers
 are for cross reference purposes only



AIR BRAKES

Hand Control Valves



Auxiliary lift axle valve
2 positions, manual
Replaces: Neway
K910058

Part Number	Description
GTA-910058	Hand control valve

Height Control Valves



Body constructed in Engineering
Grape plastic
Horizontal arm length: 12"
max
Vertical arm length: 14"
Axle bracket linkage:
vertical
Replaces: Haldex KN27000

Part Number	Description
GTA-27000	Height control valve



Controlled response
Fittings provided: 1/4"
Exhaust port: 1/8" Air
Spring port: 1/8" Supply
port: 1/8" Replaces:
Neway 90054007

Part Number	Description
GTA-90054007	Height control valve



Max length: 14"
Replaces: Haldex 48100367
Tectran 80-1006AL

Part Number	Description
GTA-Q500	Leveling link, 6 per box

Leveling Valves



Immediate Response All ports:
GTA-90554241 1/4" NPT
GTA-90554243 12mm x
1.5 Replaces: Neway 90554241
90554243

Part Number	Description
GTA-90554241	Leveling valve, (IR)
GTA-90554243	Leveling valve, (IR)

Low Pressure Indicators



Body height: 1-15/16"
Pipe Thread: 1/4"
Cut-out Pressure: GTA-279472 75 - 6
GTA-228750 60 - PSI
Single Terminal - GTA-279472
Double Terminal - GTA-228750
Replaces: Bendix 279472 (LP-3)
228750 (LP-3)

Part Number	Description
GTA-279472	Low pressure indicator
GTA-228750	Low pressure indicator

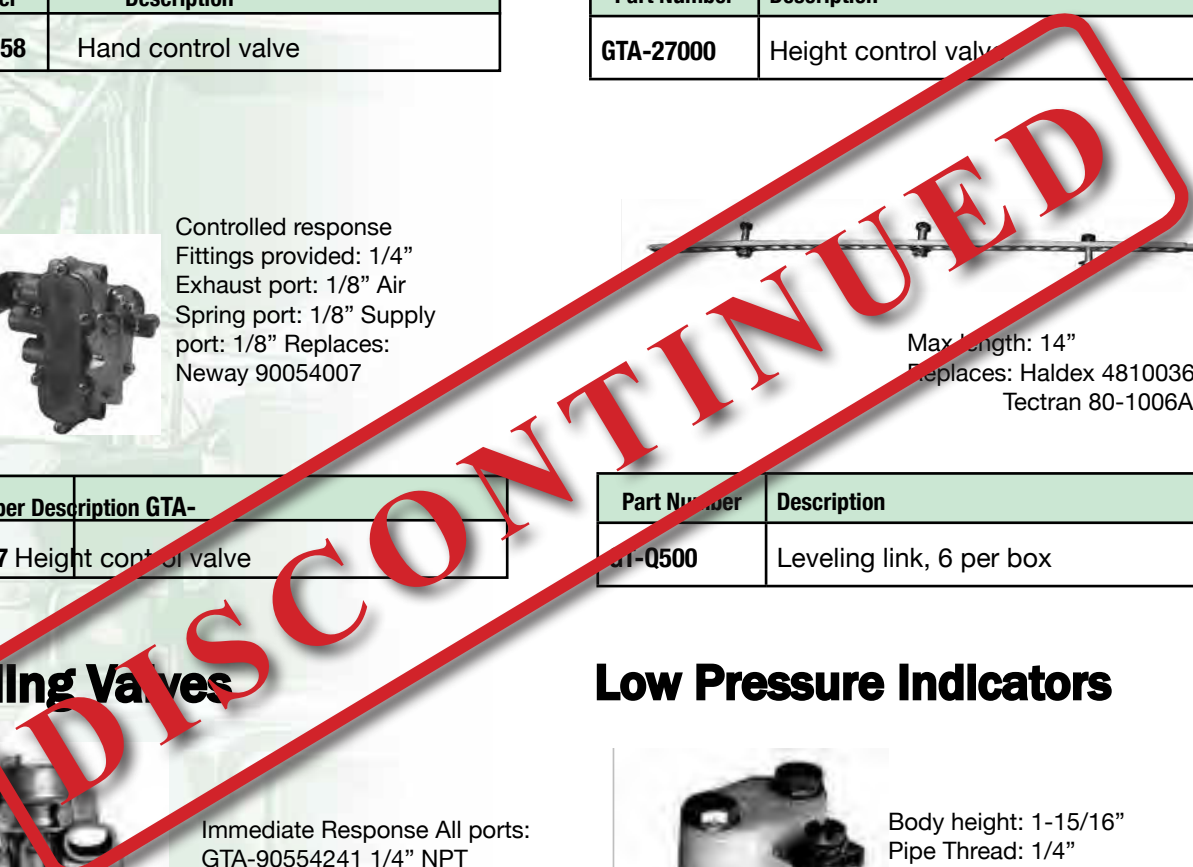



Multifunction Valves



Trailer spring brake valve
 Delivery ports: (4) 3/8" PT
 Supply ports: (1) 3/8" PT
 Reservoir (A): 1/2" PT
 Reservoir (B): 3/8" PT
 Control ports: (1) 3/8" PT
 Closing Pressure: 55 PSI
 Replaces: Haldex KN 26000 (RT-4)

Part Number	Description
GTA-26000	Multifunction valve

Pilot Valves



3 Way Replaces:
 Neway 90054079 and
 90054088

GTA-90054079 GTA-90054088

Part Number	Description
GTA-90054079	Pilot valve
GTA-90054088	Air suspension valve

Pressure Protection Valves



Williams style with
 filter Replaces: Neway
 90054107 Replaces:
 Williams WM778A1

Part Number	Description
GTA-90054107	Pressure protection valve

Push/Pull Valves



Overall height: 4-25/32"
 Delivery ports: (1) 1/4" PT
 Supply ports: (1) 1/8" PT
 Control ports: (1) 1/8" PT
 Automatic Release Pressure:
 40 PSI Replaces: Bendix
 288239 (PP-7)

Part Number	Description
GTA-288239	Push/Pull valve

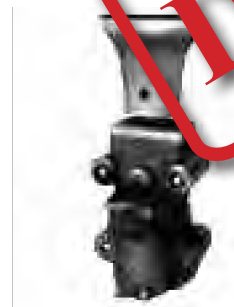
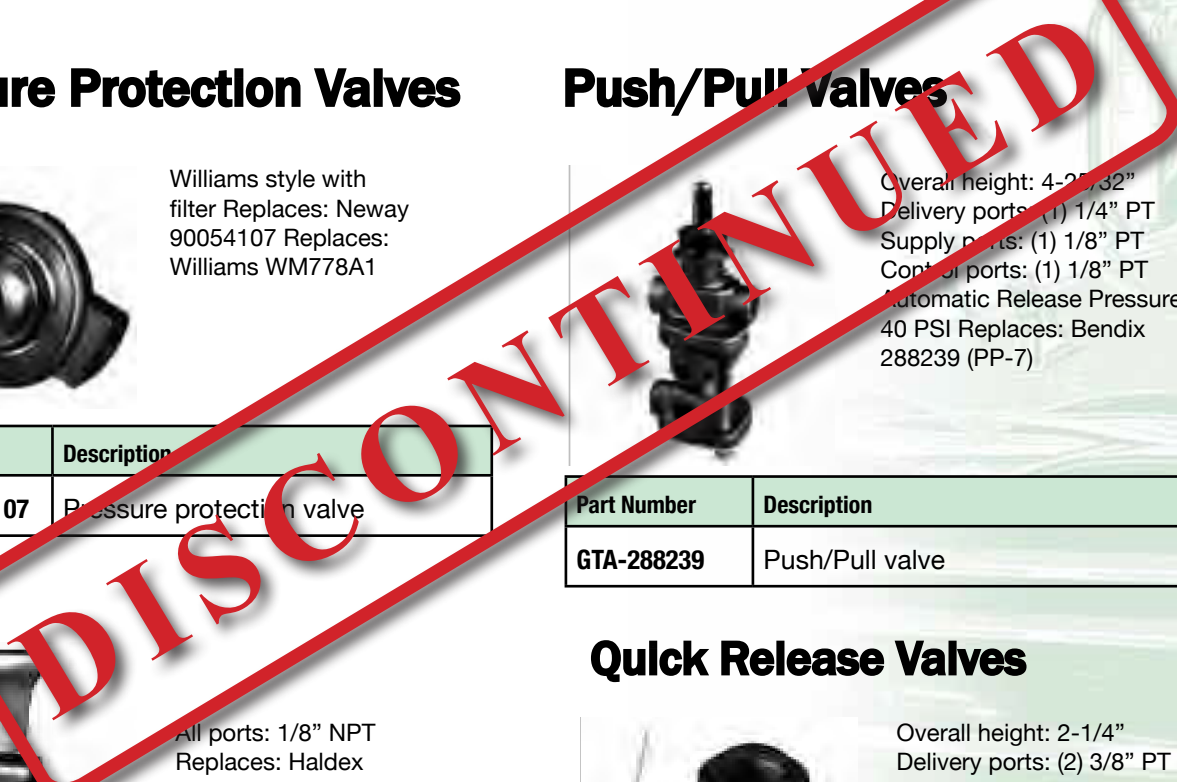

All ports: 1/8" NPT
 Replaces: Haldex
 KN3546

Part Number	Description
GTA-3546	Push/pull type valve transmission range

Quick Release Valves



Overall height: 2-1/4"
 Delivery ports: (2) 3/8" PT
 Supply ports: GTA-065066 (1) 1/2"
 GTA-065067 (1) 3/8"
 Crack Pressure: 1 PSI
 Mounting holes: 11/32" dia.,
 1-1/2" C-C
 Replaces: Bendix 065066 (QRN)
 Bendix 065067 (QRN)

Part Number	Description
GTA-065066	Quick release valve
GTA-065067	Quick release valve



Quick Release Valves



Overall height: 2-1/2"
 Overall width: 3-1/4"
 Delivery ports: (2) 3/8" PT
 Supply ports: GTA-229859 (1) 3/8"
 GTA-229860 (1) 1/2"
 Crack Pressure: 1 PSI
 Mounting holes: 11/32" dia., 1-1/2" C-C
 Replaces: Bendix 229859 (QR-1A) Bendix
 229860 (QR-1B)



Overall height: 2-11/16"
 Delivery ports: GTA-289714 (2) 3/8" PT
 GTA-289182 (2) 1/4" PT
 Supply ports: (1) 1/4" PT
 Balance: (1) 1/4" PT
 Mounting holes: 11/32" dia., 1-1/2" C-C
 Replaces: Bendix 289714 (QR-1C)
 Bendix 289182 (QR-1C)

Part Number	Description
GTA-229859	Quick release valve
GTA-229860	Quick release valve

Part Number	Description
GTA-289714	Quick release valve
GTA-289182	Quick release valve

Relay Valves



Body height: 3-7/8"
 Delivery ports: (4) GTA-065104 = 3/8" PT
 GTA-102626 = 1/2" PT
 Supply ports: (1) 1/2" PT
 Service ports: (1) 1/4" PT
 Crack Pressure: 1 PSI
 Replaces: Bendix 065104 (R-12)
 102626 (R-12)

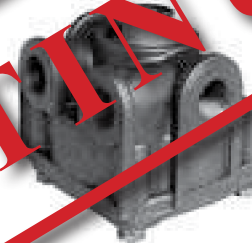

Body height: 3-7/8"
 Delivery ports: (2) 1/2" PT
 Supply ports: (2) 3/4" PT Service ports:
 (1) 1/4" PT
 Crack Pressure: 4 PSI
 Replaces: Bendix 103009 (R-12)

Part Number	Description
GTA-065104	Relay valve, vertical ports
GTA-102626	Relay valve, vertical ports

Part Number	Description
GTA-103009	Relay valve, horizontal ports 3/4" G port

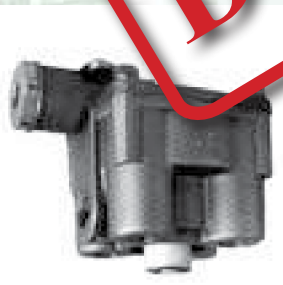

Body height: 4-7/16"
 Delivery ports: (4) 1/2" PT
 Supply ports: (1) 1/2" PT
 Service ports: (1) 1/4" PT
 Balance ports: (1) 1/8" PT - located beneath
 exhaust plate
 Crack Pressure: 4 PSI
 Replaces: Bendix 103028 (R-14)



Body height: 4-7/16"
 Delivery ports: (2) 1/2" PT
 Supply ports: (2) 3/4" PT
 Service ports: (1) 1/4" PT
 Balance ports: (1) 1/8" PT - located
 beneath exhaust plate
 Crack Pressure: 4 PSI
 Replaces: Bendix 103010 (R-14)

Part Number	Description
GTA-103028	Relay valve, vertical ports

Part Number	Description
GTA-103010	Relay valve





Relay Valves



Part Number	Delivery Ports (2)	Service/Control Ports (1)	Supply/Reservoir Port (A)	Supply/Reservoir Port (B)	Control Position	Includes Plug	Replaces Haldex#
GTA-28500	3/8"	1/4" NPT	3/8"	3/8"	90°	(1) 3/8"	KN28500
GTA-28510	3/8"		3/8"	1/2"		(1) 1/2", (1) 3/8"	KN28510
GTA-28520	1/2"		1/2"	1/2"		(1) 1/2"	KN28520

RG-2 relay valve



Body height: 5-5/64"
 Delivery ports: (2) 1/4" PT
 APT Delivery: (2) 3/8" PT
 Supply ports: (A) 3/4" PT
 (B) 3/8" PT
 Service ports: (1) 1/4" PT
 Emergency ports: (1) 1/4" PT
 Replaces: Bendix 281865 (RE-6)



Service emergency relay valve (serv)
 For use on pre-121 trailers
 (before 1974)
 Crack Pressure: 4.5 PSI
 Replaces: Midland 12352

Part Number	Description
GTA-281865	Relay valve, emergency

Part Number	Description
GTA-12352	Relay valve



Delivery ports: (4) 3/8" NPT
 Supply ports: (1) 1/4" NPT
 Control ports: (1) GTA-110200 1/4" NPT GTA-110205 3/8" NPT
 Reservoir ports: (1) 3/4" NPT
 Ratio feature: yes
 Normal crack pressure: 4.5 PSI
 Replaces: Sealco 110200
 Sealco 110205



Overall height: 5-13/32"
 Delivery ports: (4) 3/8" PT
 Supply ports: (1) 1/2" PT
 Control ports: (1) 1/8" PT
 Service ports: (1) 1/4" PT
 Crack Pressure: GTA-065145 4 PSI
 GTA-065146 5.5 PSI
 Replaces: Bendix 065145 (BP-R1)
 Bendix 065146 (BP-R1)

Part Number	Description
GTA-110200	Relay valve, emergency
GTA-110205	Relay valve, emergency

Part Number	Description
GTA-065145	Relay valve, bobtail brake proportioning
GTA-065146	Relay valve, bobtail brake proportioning

all references to competitors' part numbers are for cross reference purposes only



AIR BRAKES

Relay Valves

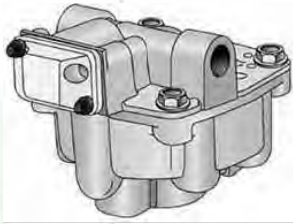

Delivery ports: (4) GTA-30300 1/4" GTA-30400 3/4"
 Reservoir ports: (1) 3/4" Service inlet: (1) 1/4" Emergency inlet: (1) 1/4" Includes nipple Crack Pressure: 3 PSI Replaces: Haldex KN30300

KN30400

Part Number	Description
G T A - 3 0 3 0 0	Relay valve, emergency
G T A - 3 0 4 0 0	Relay valve, emergency



Delivery ports: (4) 3/8" NPT Control ports: (1) 3/8" NPT Reservoir ports: (1) 3/4" NPT Normal crack pressure: 4 PSI Replaces: Sealco 110415

Part Number	Description
GTA-110415	Relay valve. 4 port service



Supply port: 3/8" PT Control port: 3/8" PT Reservoir port A: 1/2" PT Reservoir port B: 1/2" PT Delivery port: 3/8" Replaces: Sealco 110197

Part Number	Description
GTA-110197	Relay valve. 2 port service



Body height: 3-19/32"
 Body width: 5-13/16"
 Delivery ports: (2) 1/2" PT
 Delivery ports: (1) 1/4" PT
 Supply port: (2) 3/4" PT
 Service port: (1) 1/4" PT - located at 90°
 Balance ports: (1) 1/8" PT - located under exhaust cover
 Replaces: Bendix 286370 (R-8)

Part Number	Description
GTA-286370	Relay valve

DISCONTINUED

Safety Valves Assemblies

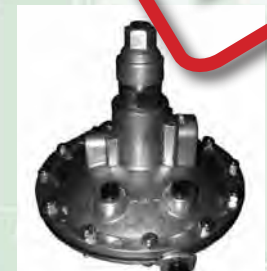

Delivery Ports: (4) 1/4" NPT Supply Ports: (1) 1/4" NPT Control Ports: (1) 1/4" NPT Reservoir Ports: (1) 1/2" NPT Normal Crack Pressure: 1.5 PSI Replaces: Sealco A1000S

Part Number	Description
GTA-A10005	Relay valve with brass, emergency



Pressure: 250 PSI
 Thread: 1/2" NPT
 Holes: 1
 Used with Tu-Flo 550 and 750 compressor
 Replaces: Bendix 131081 (ST-4)

Part Number	Description
GTA-131081	Safety valve assembly

all references to competitors' part numbers are for cross reference purposes only



Safety Valves Assemblies



GTA-205105
 All ports: 1/4" NPT
 Replaces: Bendix 205105 (ST-1)
 GTA-284143
 PT: 3/8"
 Pressure setting: 150 PSI
 Replaces: Bendix 284143 (ST-3)

Part Number	Description
GTA-205105	Safety valve assembly
GTA-284143	Safety valve assembly

Solenoid Valves



GTA-90054074 All ports: 1/4"
 NPT Replaces: Neway 90054074
 90054075

Part Number	Description
GTA-90054074	Solenoid valve (closed) directional control
GTA-90054075	Solenoid valve (open) directional control

Spring Brake Valves



12 volt direct current
 Manual override
 Universal - normally opened or closed
 Replaces: Neway 90054076

Part Number	Description
GTA-90054076	Solenoid valve directional control



Delivery ports: (4) 3/8" PT
 Service ports: (1) 1/4" PT
 Service/Spring brake reservoir: (1) 1/4" PT
 Trailer Supply: (1) 1/4" PT
 Trailer Service: (1) 1/4" PT
 Reservoir mounting: (1) GTA-065437 male 3/4" PT
 GTA-065439 male 1/2" PT
 Replaces: Bendix 065437 (SR-5)
 065439 (SR-5)

Part Number	Description
GTA-065437	Spring brake valve
GTA-065439	Spring brake valve



Delivery ports: (4) 3/8" NPT Supply ports:
 (1) 3/8" NPT Control ports: (1) 3/8" NPT
 Reservoir (A): 1/2" NPT Reservoir (B): GTA-
 110170 1/2" NPT
 GTA-110171 3/8" NPT Cover Rotate: GTA-110170
 none GTA-110171 90 degrees Replaces:
 Sealco 110170
 110171

Part Number	Description
GTA-110170	Spring brake valve
GTA-110171	Spring brake valve



Body height: 4-3/16" Body width:
 4-5/8" Delivery ports: (1) 1/4" PT
 Supply ports: (1) 1/4" PT Control ports:
 (1) 1/4" PT Reservoir ports: (1) 1/4"
 PT Reservoir Trip Pressure: 55 PSI
 Replaces: Bendix 286364 (SR-1)

Part Number	Description
GTA-286364	Spring brake valve

all references to competitors' part numbers
 are for cross reference purposes only



AIR BRAKES

Spring Brake Valves



Body height: 5-17/32"
 Delivery ports: (4) 3/8" PT
 Trailer supply ports: (1) 1/4" PT
 Trailer service ports: (1) 1/4" PT
 Service reservoir ports: (2) 1/4" PT
 Reservoir connection: (1) 3/4" male PT
 Replaces: Bendix 102761 (SR-2)

Part Number	Description
GTA-102761	Spring brake valve

Stop Light Switches



Body height: 2-1/4"
 Body width: 1-5/8"
 Pipe thread: 1/4"
 Terminal thread: 8-32
 Replaces: Bendix 228600 (SL-4)

Part Number	Description
GTA-228600	Stop light switch



Body height: 5-3/4" Delivery ports: (4) 3/8" PT
 Reservoir charging ports: (2) 1/4" PT Trailer
 supply ports: (1) 1/4" PT Trailer service ports:
 (1) 1/4" PT Reservoir connection: (1) 3/4" male PT
 GTA-101112
 3/4" male PT
 GTA-101622 1/2" male PT
 Replaces: Bendix 101112 (SR-4)
 101622 (SR-4)

Part Number	Description
GTA-101112	Trailer spring brake valve
GTA-101622	Trailer spring brake valve



Body height: 4-1/4" Tractor service
 ports: 3/8" PT Tractor emergency
 ports: 1/4" PT Trailer service ports: 1/2"
 PT Trailer emergency ports: 1/2" PT
 Replaces: Bendix 279000 (TP-3)

Part Number	Description
GTA-279000	Tractor protection valve

Transmission Slave Valves



All ports: 1/8" NPT Replaces:
 Haldex KN4688

Part Number	Description
GTA-A4688	Transmission slave valve



All ports: 1/8" NPT Replaces:
 Fuller A-5000

Part Number	Description
GTA-A5000	Transmission slave valve

DISCONTINUED

all references to competitors' part numbers
 are for cross reference purposes only



Air Dryers



GTA-065612



GTA-109493



GTA-5001247

AD-IP Style Dryers & Components

Part Number	Description	Replaces
GTA-065612	AD-IP Air Dryer 12 volt	065612
GTA-109493	AD-IP Air Dryer Cartridge	109493
GTA-800404	AD-IP Purge Valve	800404
GTA-5001247	AD-IP Bracket Kit	800404
GTA-K022105	AD-IP Purge Valve Kit	K022105

AD-9 Style Dryers & Components

Part Number	Description	Replaces
GTA-065225	AD-9 Air Dryer 12 volt	065225
GTA-065224	AD-9 Air Dryer 24 volt	065224
GTA-107796	Desiccant Cartridge	107796
GTA-107695	Bracket Kit	107695
GTA-800405	Purge Valve -12 volt	800405
GTA-5004338	Purge Valve -24 volt	5004338
GTA-5005037	Purge Valve Kit	5005037
GTA-109578	Heater & Thermostat -12 Volt	109578
GTA-109579	Heater & Thermostat -24 Volt	109579
GTA-109869	Wiring Harness	109869
GTA-107800	Check Valve Kit - 1/2"	107800
GTA-107799	Check Valve Kit - 1/2"	107799
GTA-800350	Pressure Relief Valve	800350

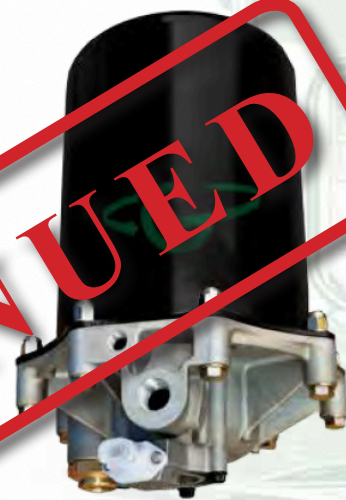

- Long purge cycle and almost 4 lbs of desiccant ensures more contaminant & moisture removal
- Desiccant cartridge long life extends maintenance intervals
- Soft seat purge valve seal in all Air Dryers and Kits
- Cartridges & Kits include all replaceable O-Rings



GTA-5004341



GTA-107794

all references to competitors' part numbers are for cross reference purposes only



AIR BRAKES

Air Dryers

Part Number	Description	Replaces
GTA-955205K	Model 1200 Dryer Kit 12v	R955205
GTA-955300	Model 1200P Dryer Only 12v	R955300

- Air Dryer for class 7 & 8 on-highway tractors • Spin-on desiccant cartridge • Cartridges and Kits include all replaceable O-Rings



GTA-950011



GTA-1003100



GTA-33100

Part Number	Description	Replaces
GTA-950011	Desiccant Cartridge	R950011
*7\$950014	Purge Valve -Kit	R950014
GTA-950015	Heater Kit -12 volt	R950015
GTA-950002	Heater Harness	SRWABC002
GTA-950044	Regeneration Valve Kit	R950044
GTA-950045	Diaphragm for Regen. Valve	R950045
GTA-950017	Outlet Check Valve -Kit	5005037
GTA-1003100	Pressure Control Check Valve	S4341003100
GTA-1226	Pressure Relief Valve	S2206D1226
GTA-950013	Turbo Cut-Off Kit	R950013



GTA-950015



GTA-950044

Part Number	Description	Replaces
GTA-33100	Dryer Only 12v	DA33100

- Long purge cycle ensures more contaminant & moisture removal
- Easy desiccant cartridge removal
- Kits include all replaceable O-Rings
- New parts - no core charges

all references to competitors' part numbers are for cross reference purposes only



Air Dryers



GTA-6026



GTA-800404



GTA-022105



GTA-109495



Part Number	Description	Replaces
GTA-6026	Desiccant Cartridge & Repair Kit	DQ6026
GTA-6020	Lower Housing Kit	DQ6020
GTA-6013	Heater Kit - 12 Volt	DQ6013
GTA-31527	Pressure Relief Valve	KN31527

Part Number	Description	Replaces
GTA-800404	Early Purge Valve Kit for Models IP & IS Dryers - 12 Volt	800404
GTA-022105	Late Purge Valve Kit for Models IP & IS Dryers	022105

Part Number	Description	Replaces
GTA-109495	Model IP & IS Dryers - 12 Volt	109495

Part Number	Description	Replaces
GTA-724	1st Generation Cartridge T2000 dryer	T224
GTA-724-2	2nd Generation Cartridge T2000 dryer	T224
GTA-101900	Cartridge for Model 2 Dryer	101900
GTA-104358	Cartridge for Model 4 Dryer	104358
GTA-109994	Cartridge for Model SP/IS Dryer	109994
GTA-065624	Cartridge for Model IP Dryer	065624

Part Number	Description	Replaces
GTA-72420	Alcohol Evaporator	A72420
GTA-275491	Air Governor	275491
GTA-284358	High Temp Air Governor w/O-Rings	284358
GTA-281923	Non-Heated Drain Valve	281923
GTA-284412	Heated Drain Valve - 12 volt	284412



GTA-72420



GTA-281923



Part Number	Description
GTA-12102	2' Manual Drain Valve
GTA-12103	3' Manual Drain Valve
GTA-12104	4' Manual Drain Valve
GTA-12105	5' Manual Drain Valve
GTA-12105U	5' Manual Drain Valve -Uncrimped

all references to competitors' part numbers are for cross reference purposes only



Aluminum Gladhands



Part Number	Description	Replaces Tramec#
GT-5330	universal	36301
GT-5331	emergency (red)	36201
GT-5332	service (blue)	36101

Ten to a box



Aluminum Swivel Gladhands



GT-5351P-45

GT-5351-45

Part Number	Description	Replaces Tramec#
GT-5350-45	Gladhand - swivel only 45°	-
GT-5350-90	Gladhand - swivel only 90°	36390
GT-5351-45	Gladhand - swivel, emergency, 45° (red)	36281
GT-5351-90	Gladhand - swivel, emergency, 90°	36201
GT-5351P-45	Gladhand, swing-away, emergency, w/iron GH powder coated 45 degree	
GT-5351P-90	Gladhand, swing-away, emergency, w/iron GH powder coated 90 degree	
GT-5352-45	Gladhand service , 45 degree swing-away swivel assembly	36181
GT-5352-90	Gladhand service , 90 degree swing-away swivel assembly	36191
GT-5352P-45	Gladhand, swing-away, service, w/iron GH powder coated 45 degree	
GT-5352P-90	Gladhand, swing-away, service, w/iron GH powder coated 90 degree	
GT-5353	Iron swivel Gladhand red 'emergency' 1 piece cast	36233
GT-5354	Iron swivel Gladhand yellow 'service' 1 piece cast	36133



Iron Swivel Gladhands



Air Brakes

all references to competitors' part numbers are for cross reference purposes only



Shut-off Gladhands



Knob Style



Lever Style

Part Number	Description	Replaces Tramec#	Replaces Phillips
GT-5338	emergency, shut-off Phillips	9212	12-310
GT-5338S	emergency, Sloan style, shut-off	9203	441014
GT-5339	service, shut-off Phillips	9211	12-306
GT-5339S	service, Sloan style, shut-off	9202	441004

37 Degree Bracket Mount Gladhands



GT-5317



GT-5327

Part Number	Description	Replaces Phillips
GT-5317	service, 37° mounting	12-136
GT-5327	emergency, 37° mounting	12-138

DISCONTINUED

Xtreme Gladhands



GT-5333X
universal



GT-5334X 1 red 1
blue set

Part Number	Description	Replaces Tramec
GT-5333X	Xtreme, aluminum, Universal	36301P
GT-5334X	Xtreme, red/blue SET	36201P & 36101P

- Powder-coated body - red/blue & black
- Stainless steel wear plate & clasp
- Urethane seal
- Stainless steel screen & screws
- Clamshell packaged

all references to competitors' part numbers are for cross reference purposes only



Cast Iron Gladhands



Part Number	Description	Replaces Tramec#
GT-5335	Universal	56321
GT-5336	emergency	56221
GT-5337	service	56121

"V" Series

- Zinc plated, dichromated one piece
- Supplied with (GT-2600) rubber seal

"Quick-E" Style Replacement



GT-5383

Quick Release

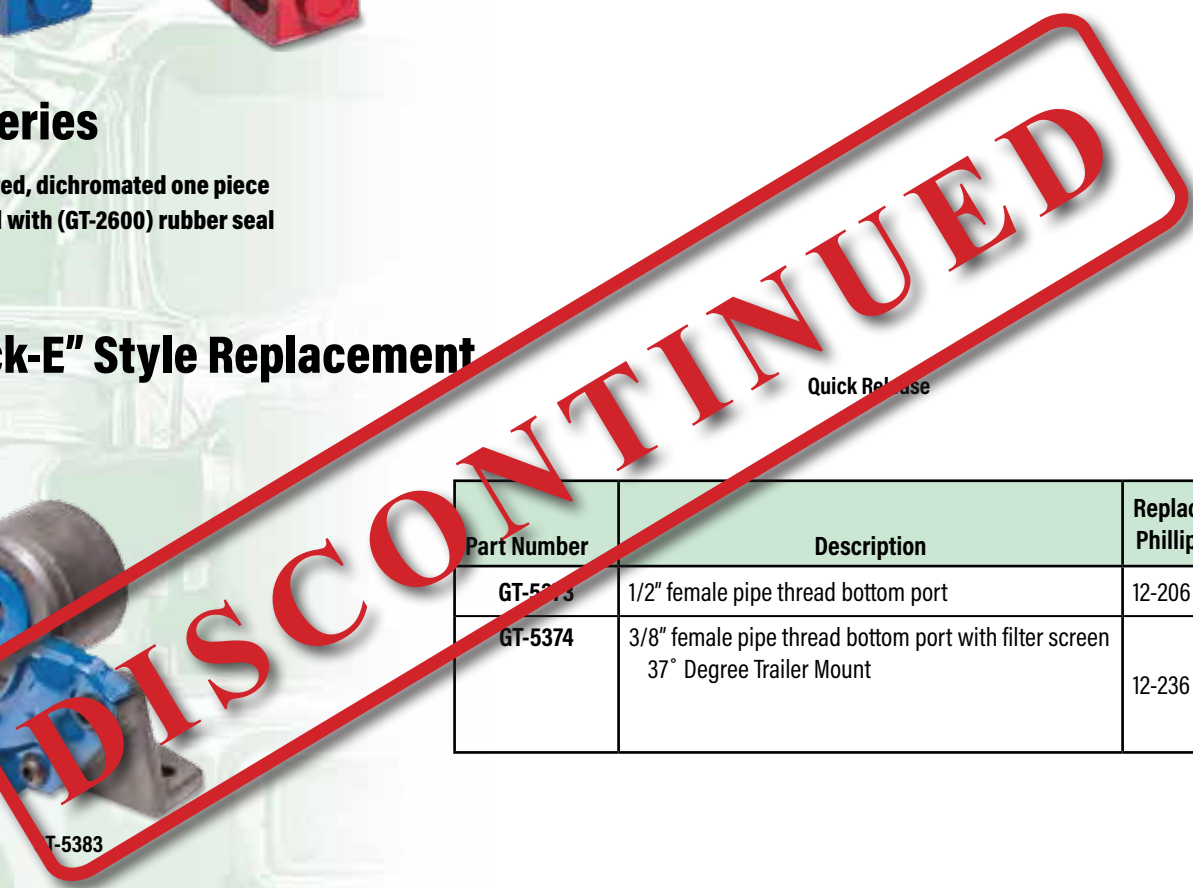

Part Number	Description	Replaces Phillips#
GT-5373	1/2" female pipe thread bottom port	12-206
GT-5374	3/8" female pipe thread bottom port with filter screen 37° Degree Trailer Mount	12-236

Poly Seal Kits

- Red & blue poly seal kits
- 2 seals per kit



Part Number	Description
GT-2609	Seal kit, double lip, large face combines GT-2606 & GT-2607
GT-2605GLO	Seal kit, small face combines GT-2601 & GT-2602
GT-2605WS	Gladhand seal kit with built-in filters small face, red/blue

all references to competitors' part numbers are for cross reference purposes only



Rubber Seals



Single Lip



Double Lip



Protecto

Part Number	Description	Replaces Tramec No.	Replaces Tectran No.
GT-2599	Single lip	36003	101112
GT-2600	Double lip	36001	10111
GT-2604	Protecto	-	101113

100 each per Poly Bag

Filters

GT-2601WS (red)

GT-2602WS (blue)

T-2603WS (black)

- Urethane small face
- Stainless steel screen

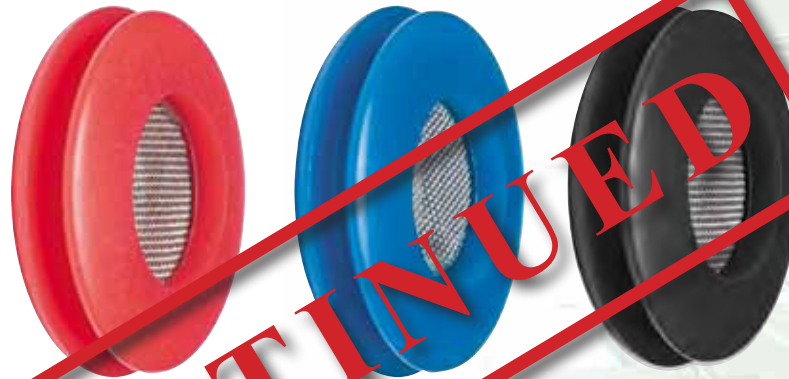

(Bags 25 each to a bag)

DISCONTINUED

Polyurethane Seals



Small Face



Large Face

Part Number	Description	Color	Replaces Tectran No.
GT-2601	Small face	Red	101115R
GT-2602	Small face	Blue	101115B
GT-2603	Small face	Black/Gray	101114
GT-2601WS	Small face with built in filter	Red	
GT-2602WS	Small face with built in filter	Blue	
GT-2603WS	Small face with built in filter	Black/Gray	
GT-2606	Large Face	Red	101119R
GT-2607	Large Face	Blue	101119B
GT-2608	Large Face	Black/Gray	101118

100 each per Poly Bag

all references to competitors' part numbers are for cross reference purposes only



AIR BRAKES

Gladhand Locks



- Indestructible plastic body
- Stainless steel & zinc plated hardware
- Multiple key patterns available

Part Number	Description	Key	Replaces
GT-7200	Gladhand Lock and Key	GT-611K	1011LK
GT-7200-E100	Gladhand Lock and Key	GT-E100K	
GT-7200-E101	Gladhand Lock and Key	GT-E101K	

ONE KEY FITS YOUR KING PIN LOCK AND GLANDHAND LOCK! SECURE YOUR TRAILER WITH TWO LOCKS ONE KEY!



Part Number	Description
GT-611K	Keys only-set
GT-E100K	Keys only-s
GT-E101K	Keys only-set

Dummy Shutoff Gladhands



Die cast aluminum

Part Number	Description	Replaces Tramec#
GT-5345	w/stainless steel cable	1010-F18
GT-5345FX	red cable 21" long HD-eyelet	
GT-5348	red cable 11" long HD-eyelet	



red cable for GT-5348 & GT-5345FX

Part Number	Description	Replaces Sloan#
GT-5347	Glaghand clear chromate	44731
	Packaged 2 per bag	

Dummy Coupling Mounts

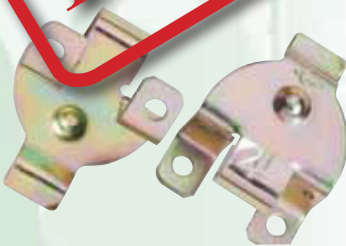

Stamped

Part Number	Description	Replaces Tectran#
GT-5346V	Stamped steel vented	9412
GT-5346NV	Stamped steel non-vented	9411

all references to competitors' part numbers are for cross reference purposes only



Stainless Steel Screens

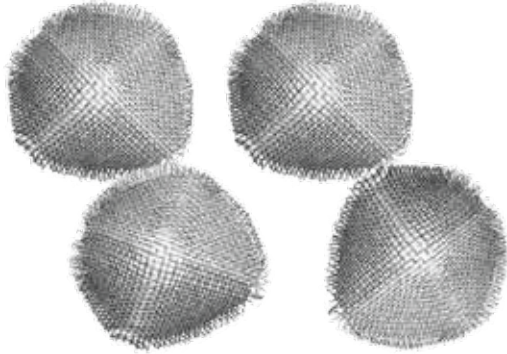

- Replacement screens for Xtreme Gladhands
- Prevents dirt from entering airline
- 20 each per bag

Part Number	Description	Replaces Phillips
GT-12-038	stainless steel dome style	12-038
GT-12-039	Stainless steel, flat style	12-039

In-Line Quick Release Valve



- Exhaust valves mount in-line between gladhand and the tractor protection valve to speed up release of the trailer's service brakes
- Helps reduce wear on trailer brake components
- Helps improve brake timing

DISCONTINUED

Part Number	Description	Ports	Replaces Tectran
GTA-80-1094	Mounts between tractor protection valve and trailer hose	1/2" NPTF	80-1094
GTA-80-1095	Mounts at gladhand end of trailer hose	1/2" NPTF	80-1095

GT-2610 Gladhand Pacifier

- Gladhand pacifiers are easily attached in any convenient location
- Simply plug into the gladhand when disconnected
- Prevents dirt and contaminants from entering the air system
- Replaces Tectran 1011P



all references to competitors' part numbers are for cross reference purposes only



Rubber Grip GT-5343 Gladhand Grips



- Unique rubberized gladhand grips
- May be used on rubber hose assemblies or aircoils
- Protect hose/tubing during gladhand connection
- Allow gladhand bend restriction during tight turns

Part Number	Description	Replaces Tectran
GT-5343	Flexible grip gladhand grip 1 red and 1 blue	1011FG

GT-5341 - Anodized Gladhand Grips

- Helps prevent air line kinking at the fittings
- One piece design
- No screws or plastic parts
- Easy to install aluminum hex construction
- Class II anodized coating provides greater corrosion resistance

The unique all hex design allows positive wrench leverage at both ends of handle.



DISCONTINUED



Plastic Grip GT-5340 Gladhandles

Standard

1 each red & blue in clamshell package

Part Number	Description	Replaces Tectran#
GT-5340	Gladhand set, standard	1011G

all references to competitors' part numbers are for cross reference purposes only



Brake Shoe Hardware Kits



Part Number	Replaces BWP	Replaces Euclid#	Contains	Use With
GTA-MK79	BWP MK79	E3869	2M-2724 Roller, 2 M-3355 Anchor Pin, 1 M-556 Return Spring, 1 M-3357 Spring, 1 M-3358 Plate, 2 M-3339 Washers, 2 M-2459 Lock Nut	Meritor (Rockwell) 15" Front Brake Shoes
GTA-MK39	BWP MK39	E2769S	2 M-1422 Anchor Pin, 2 M-596 Roller Pin, 1 M-2732 H.D. Spring, 2 M-747 Bushing	16 1/2" Shoes
GTA-MK72	BWP MK72	E2765HD	2 M-1422 Anchor Pin, 2 M-2204 Roller Pin, 1 M-2732 H.D. Spring, 2 M-747 Bushing, 2 M-1433 Retainer, 2 M-1500 Spring Pin	16 1/2" Shoes
GTA-MK7	BWP MK7	E1816HD	2 M-771 Anchor Pin, 2 M-596 Roller Pin, 1 M-792 H.D. Spring, 1 M-747 Bushing, 2 M-644 Retainer, 4 M-748 Washer, 2 M-1500 Spring Pin, 4 M-1523 Lock Pin	Meritor/Dana 16 1/2" Universal Kit
GTA-MK10	BWP MK10		2 M-592 Roller, 2 M-612 Roller Pin, 1 M-1014 H.D. Spring, 2 M-844 Spring	Eaton 4311 Shoes
GTA-MK42	BWP MK42	E3710S	2 M-2748 Anchor Pin, 2 M-596 Roller Pin, 2 M-747 Bushing, 1 M-2732 H.D. Spring, 2 M-1423 Spring, 2 M-1428 Retainer, 1 M-1430 Cotter Pin, 2 M-1500 Spring Pin	Fruehauf/Propar XEM3 Shoes

BETTER PARTS BETTER PRICES!

all references to competitors' part numbers are for cross reference purposes only



SUSPENSION

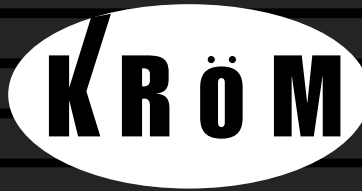

INTERNATIONAL WORLD CLASS AIR SPRINGS

For OEM & Aftermarket

**CALL OR EMAIL
TODAY FOR
CURRENT LIST
OF PART #s
IN STOCK!**



DISCONTINUED

- 2.5 Million Cycles
- 144/Hrs. Salt Spray
- 100% Pressure Tested
- Standard 4mm Thick Plates
- Dupont Nylon Made in USA
- ISO Certified
- All Components Made IN HOUSE

KRÖM Branded Air Springs are the highest Quality Springs on the Market. Other manufacturers are for reference only in this catalog. KRÖM International warranties all products to be manufactured of the highest quality standards and free of any defects.

King Pin Locks



Part Number	Description
GT-7201	Standard king pin lock, yellow
GT-611K	Keys only 2 each

- Steel fabricated body
- Yellow powder coated



Part Number	Description
GT-7201-E100	E-100 King pin lock orange
GT-E100K	Keys only 2 each
GT-7201-E101	E-101 King pin lock, orange
GT-E101K	Keys only 2 each

- Steel fabricated body
- Orange powder coated

Heavy Duty King Pin Locks



Part Number	Description
GT-7202-01	Heavy duty king pin lock (key #01)
GT-7202-01K	Key #01 only - for king pin lock
GT-7202-02	Heavy duty king pin lock (key#02)
GT-7202-02K	Key #02 only - for king pin lock
GT-7202-05	Heavy duty king pin lock (key #05)
GT-7202-05K	Key #05 only - for king pin lock
GT-7202-611K	Keys only for GT-7200 glandhand lock & GT-7201 king pin lock

GT-7208-Flag for king pin lock can be ordered separate or by adding "F" at end of part # EXAMPLE: GT-7201F standard king-pin with flag

Glandhand Locks



Part Number	Description
GT-7200	Glandhand lock 611K-Key
GT-7200-E100	Glandhand lock E100K-Key
Gt-7200-E101	Glandhand lock and E101K-Key

- Indestructible plastic bod
- Stainless steel & zinc plated hardware
- Multiple key patterns available



Part Number	Description
GT-E100K	Keys only for GT-7200
GT-E101K	Keys only for GT-7200-E100
GT-611K	Keys only for GT-72000-E101

**ONE KEY FITS YOUR KING PIN LOCK AND GLANDHAND LOCK!
SECURE YOUR TRAILER WITH TWO LOCKS ONE KEY!**

all references to competitors' part numbers are for cross reference purposes only



GT-7001- Coil Rack

- Heavy duty coil rack
- Powder coated

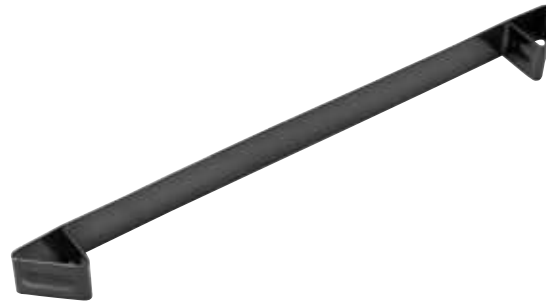

GT-1330 - Fifth Wheel Puller

- Fifth wheel hook
- Powder coated



Slick Discs

- Polyethylene with plated snap ring
- Easy installation

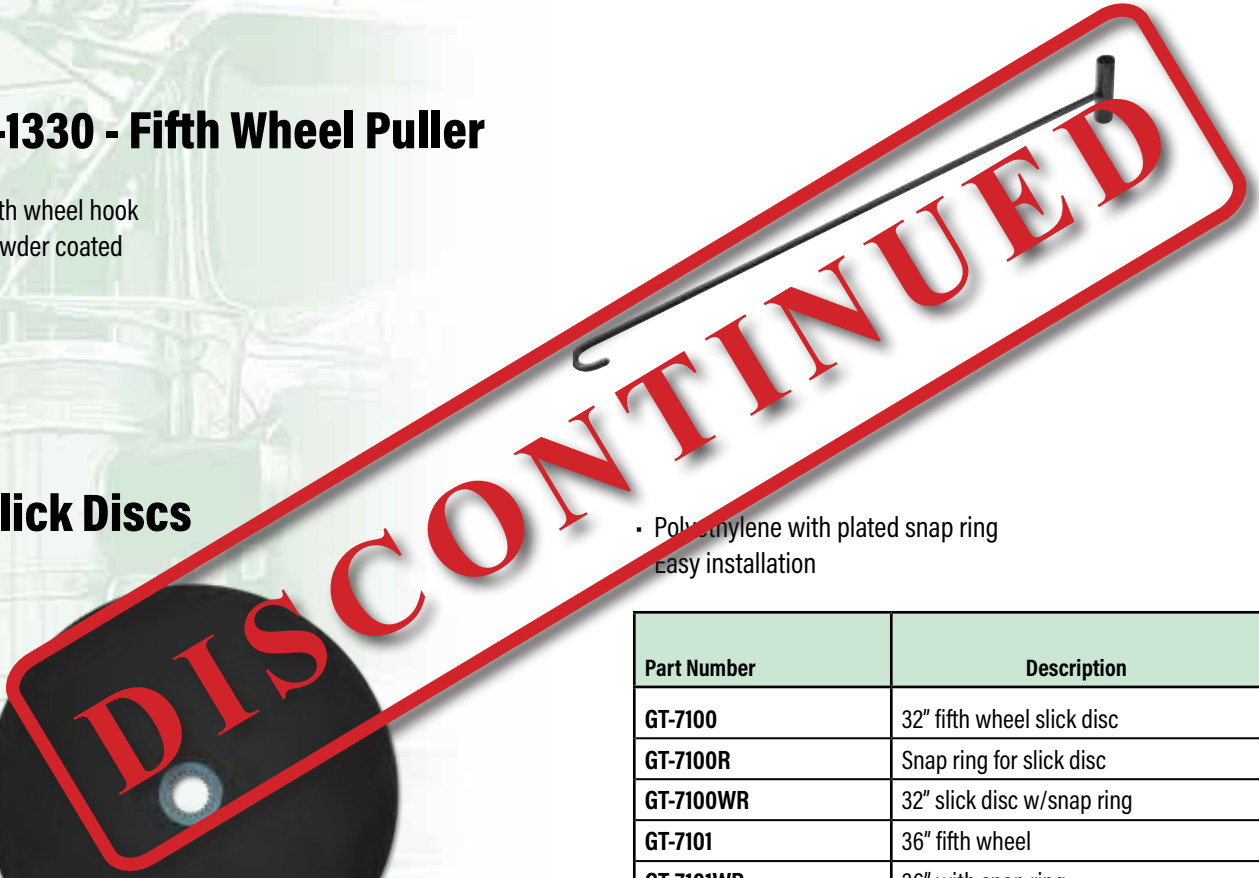

Part Number	Description
GT-7100	32" fifth wheel slick disc
GT-7100R	Snap ring for slick disc
GT-7100WR	32" slick disc w/snap ring
GT-7101	36" fifth wheel
GT-7101WR	36" with snap ring

GT-7100

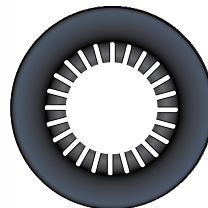

GT-7100R
Spring Steel Retaining Ring Heat Tested

Note: Silver rings are low quality copies of Globetech rings

all references to competitors' part numbers are for cross reference purposes only



Emergency Triangle Kits



Part Number	Description
GT-8500	Triangle warning kit, 3 triangles per kit with plastic container

Emergency Triangle Kit

- Each kit contains three HD triangles packaged in a red storage box
- Durable fluorescent orange plastic with red reflectors are visible day or night.
- Snaps together for fast and easy set up
- Heavy weighted sand filled base provides stability even in windy conditions
- Friction pads on base keeps triangle in place on highway
- Meets all applicable FMVSS 12 and SAE/DOT specifications
- Instructions for proper use molded in the cover and on all triangles

Make sure your vehicle meets FMVSS 125

- FMVSS 125 establishes shape, size and performance requirements for non-powered day and night warning devices that can be erected on or near the roadway to warn approaching traffic of the presence of a stopped vehicle. The purpose of this Standard is to reduce deaths and injuries due to rear-end collisions between moving traffic and disabled vehicles
- Required Application: buses and trucks with GVWR greater than 4,536 kg (10,000 lbs.)



MISCELLANEOUS

GTK-20015 - Universal Lock Rod Assembly

Replaces: Power Brace
P50015 DL-DL Kit 165408

Lockrod Assembly Kit



KIT - 50015

- Guide plates - 2**
- Guide plate half bushings - 4**
- Rod guide - 1**
- Rod guide half bushings - 2**
- Seal plate - 1**
- Seal pin - 1**

all references to competitors' part numbers
are for cross reference purposes only

CROSS REFERENCE



3M	Globetech	065178	GTA-065178	022-01078	GT-1323	W01-358-9321	GTK-358-9321
75-0301-6340-8	GT-27004	065179	GTA-065179	022-01087	GT-1002	W01-358-9366	GTK-358-9366
75-0301-6343-2	GT-27003	065437 (SR-5)	GTA-065437	022-01190158	GT-1003	W01-358-9367	GTK-358-9367
75-0301-6345-7	GT-27005	065439 (SR-5)	GTA-065439	024-03000	GT-1105	W01-358-9394	GTK-358-9394
Betts	Globetech	101112 (SR-4)	GTA-101112	031-00011	GT-2406	W01-358-9580	GTK-358-9580
A25	GT-2725A	101622 (SR-4)	GTA-101622	031-00414	GT-39414	W01-358-9626	GTK-358-9626
A25RLB90	GT-2725B70	102626 (R-12)	GTA-102626	031-00415	GT-39415	W01-358-9634	GTK-358-9634
A35	GT-2735A	102761 (SR-2)	GTA-102761	031-01200	GT-27516	W01-358-9640	GTK-358-9640
A35RLB40	GT-2735B40	103009 (R-12)	GTA-103009	031-01269	GT-27069	W01-358-9646	GTK-358-9646
A81	GT-2781A	103010 (R-14)	GTA-103010	031-01298	GT-27517	W01-358-9780	GTK-358-9780
A82	GT-2782A	103028 (R-14)	GTA-103028	033-00051	GT-27051	W01-358-9807	GTK-358-9807
B21	GT-2721B	131081 (ST-4)	GTA-131081	033-00053	GT-27053	W01-358-9921	GTK-358-9921
B23	GT-2723B	205105 (ST-1)	GTA-205105	033-00075	GT-2702C	W01-358-9978	GTK-358-9978
B25	GT-2725B	228600 (SL-4)	GTA-228600	033-00076	GT-2702SS	Fuller	Globetech
B29	GT-2729B	228750 (LP-3)	GTA-228750	033-00270	GT-27270	A-470	GTA-A-470
B33	GT-2733B	229859 (QR-1A)	GTA-229859	033-00277	GT-27277	A-5000	GTA-A-5000
B35	GT-2735B	229860 (QR-1B)	GTA-229860	033-00405	2406PSW	Gabriel	Globetech
B572825WTBK	GT-27B5728	275491 (D-2)	GTA-G8602	033-00864	GT-27864	83009	GTK-83009
B572825WTSK	GT-27B5728SS	276566 (PP-1)	GTA-276566	033-00865	GT-27865	83125	GTK-83125
B573025WTBK	GT-27B57	276567 (PP-1)	GTA-276567	033-00868	GT-27868	83128	GTK-83128
B573025WTSK	GT-27B57SS	277863 (E-3)	GTA-277863	033-00870	GT-27870	83203	GTK-83203
B672825WTBK	GT-27B6728	278414 (DC-4)	GTA-278414	033-03404	GT-27404	83207	GTK-83207
B672825WTSK	GT-27B6728SS	278415 (DC-4)	GTA-278415	033-04150	GT-27150	83215	GTK-83215
B673025WTBK	GT-27B67	279000 (TP-3)	GTA-279000	033-05125	GT-2701C	83312	GTK-83312
B673025WTSK	GT-27B67SS	279472 (LP-3)	GTA-279472	033-05126	GT-2701SS	83317	GTK-83317
B683025WTBK	GT-27B68	280479 (DC-1)	GTA-280479	158-A	GT-2705	83318	GTK-83318
B683025WTSK	GT-27B68SS	280479 (DC-1)	GTA-280479	Euclid	Globetech	83456	GTK-83456
B700	GT-27B700	281865 (RE-6)	GTA-281865	E-45040A	GT-45040A	85000	GTK-85000
B703000NTBK	GT-27B7	284143 (ST-3)	GTA-284143	E-4962	GT-4962	85001	GTK-85001
B703000NTCK	GT-27B7C	284412 (DV-2)	GTA-284412	E-4963	GT-4963	85003	GTK-85003
B703000NTSK	GT-27B7SS	286171 (E-6)	GTA-286171	E5568L	GT-45568L	85006	GTK-85006
B711	GT-27B711	286370 (R-8)	GTA-286370	E5568R	GT-45568R	85012	GTK-85012
B713000NTBK	GT-27B71	286773 (E-7)	GTA-286773	E45571A	GT-45571A	85031	GTK-85031
B713000NTCK	GT-27B71C	288239 (PP-7)	GTA-288239	E-5572A	GT-45572A	85043	GTK-85043
B713000NTSK	GT-27B71SS	289182 (QR-1C)	GTA-289182	E-977L	GT-4E5977L	85052	GTK-85052
B81	GT-2781B	289714 (QR-1C)	GTA-289714	E-977R	GT-4E5977R	Gabriel	Globetech
B82	GT-2782B	Boomerang	Globetech	E5988L	GT-4E5988L	85061	GTK-85061
B83	GT-2783B	WCI086	GT-2055L	E5988R	GT-4E5988R	85066	GTK-85066
B84	GT-2784B	BWP	Globetech	E-6000A	GT-46000A	85069	GTK-85069
BTL-71P5	GT-1004	MK10	GT-MK10	E-795L	GT-4E7895L	85310	GTK-85310
BTL-820012	GT-1001S	MK19	GT-MK19	E7895R	GT-4E7895R	85320	GTK-85320
K700	GT-27K700	MK39	GT-MK39	E7896L	GT-4E7896L	85724	GTK-85724
K711	GT-27K711	MK42	GT-MK42	E7896R	GT-4E7896R	85900	GTK-85900
PS-1	GT-1001	MK7	GT-MK7	Firestone	Globetech	85902	GTK-85902
RT25	GT-27RT25	MK72	GT-MK72	W01-358-6231	GTK-358-6231	85909	GTK-85909
RT35	GT-27RT35	MK79	GT-MK79	W01-358-6935	GTK-358-6935	85918	GTK-85918
Bendix	Globetech	Fleetline	Globetech	W01-358-7136	GTK-358-7136	85931	GTK-85931
229635	GT-229635	1300	GT-391300	W01-358-7555	GTK-358-7555	89408	GTK-89408
234099	GT-520	1585-BWHA	GT-391585	W01-358-7897	GTK-358-7897	89410	GTK-89410
234100	GT-520	1585FB-kit	GT-39585FB	W01-358-8050	GTK-358-8050	89423	GTK-89423
234101	GT-5209	1585HB-kit	GT-39585HB	W01-358-8091	GTK-358-8091	89429	GTK-89429
234189	GT-5206	1585LM-kit	GT-39585LM	W01-358-8204	GTK-358-8204	89451	GTK-89451
234226	GT-5211	1590-12	GT-395001	W01-358-8708	GTK-358-8708	Grote	Globetech
234362	GT-5214	1590-2BPPA	2406PSB	W01-358-8709	GTK-358-8709	82-0850	GT-3017-20K
234433	GT-5205	1590-BWHA	GT-391590	W01-358-8713	GTK-358-8713	82-0853	GT-3017
801544	GTA-801544	1600-11M	GT-391601	W01-358-8729	GTK-358-8729	82-0854	
801545	GTA-801545	1600-15M	GT-391600	W01-358-8755	GTK-358-8755	82-0855	GT-3017-20
801546	GTA-801546	1625-16	GT-391625	W01-358-8774	GTK-358-8774	82-0856	GT-3017-30
065066 (QR-N)	GTA-065066	Fleet Engineer	Globetech	W01-358-8944	GTK-358-8944	82-0857	GT-3017-20P
065067 (QR-N)	GTA-065067	021-00043	GT-1300	W01-358-9069	GTK-358-9069	82-0857	GT-3017-30P
065104 (R-12)	GTA-065104	021-00050	GT-1328	W01-358-9082	GTK-358-9082	Haldex-Midland	Globetech
065145 (BP-R1)	GTA-065145	021-00051	GT-1331	W01-358-9082	GTK-358-9082	12352	GTA-12352
065146 (BP-R1)	GTA-065146	021-00053	GT-1304	W01-358-9121	GTK-358-9121	40010140	GTA-40010140
065164	GTA-065164	021-00373	GT-1332	W01-358-9122	GTK-358-9122	40010141	GTA-40010141
065167	GTA-065167	021-00374	GT-1333	W01-358-9265	GTK-358-9265	40010142	GTA-40010142
065170	GTA-065170	022-00487	GT-1327	W01-358-9270	GTK-358-9270	40010143	GTA-40010143
065172	GTA-065172	022-00628	GT-1324	W01-358-9291	GTK-358-9291	40010144	GTA-40010144
065174	GTA-065174	022-01022	GT-1302	W01-358-9293	GTK-358-9293	40010211	GTA-40010211
065175	GTA-065175	022-01024	GT-1326	W01-358-9307	GTK-358-9307	40010212	GTA-40010212



all references to competitors' part numbers are for cross reference purposes only

CROSS REFERENCE



Phillips	Globetech	RB016	GTA-5285	340-4372	GT-4372	161201	GTA-161201
17-151	GT-5501-38	RB36CK	GTA-5286	340-4975	GT-4020	441004	GT-5339S
17-156	GT-5001-2	Reflexite	Globetech	340-5096	GT-4007F	441014	GT-5338S
17-157	GT-5001-3	V92	GT-27006	340-5097	GT-4007	1055011	GTA-1055011
17-158	GT-5001-4	V92	GT-27007	342-4009	GT-4009G	1077011	GTA-1077011
17-249	GT-5426	V92-5649	GT-27000	342-4013	GT-4013G	101115B	GT-2602
17-420	GT-5427	Sealco	Globetech	342-4024	GT-4024G	101115R	GT-2601
Ranger	Globetech	616	GTA-616	342-4195	GT-4195G	101119B	GT-2607
BTS-2024	GTA-BC2024	2550	GTA-2550	343-4009	GT-4009S	101119R	GT-2606
BTS-2424	GTA-BC2424	21600	GTA-21600	343-4024	GT-4024S	1011FG	GT-5343
BTS-2424LS	GTA-BC2424LS	110139	GTA-110139	343-4095	GT-4095S	1011G	GT-5340
BTS-2430	GTA-BC2430	110170	GTA-110170	343-4195	GT-4195S	1011P	GT-2610 GTA-12-027
BTS-2430LS	GTA-BC2430LS	110171	GTA-110171	343-4249	GT-4249S	1022-8	1022-8
BTS-3030	GTA-BC3030	110191	GTA-110191	343-4372	GT-4372S	1022-8	GTA-1022-8
BTS-3030LS	GTA-BC3030LS	110197	GTA-110197	347-4009	GT-4009H	10234-8	GTA-10234-8
BTS-3036	GTA-BC3036	110205	GTA-110205	347-4195	GT-4195H	1023-8	GTA-1023-8
BTS-3030-4.5 BC	GTA-BC3030-4.5DB	110376	GTA-110376	610-0065	GT-4065	1024-8	GTA-1024-8
3030-WCR	GTA-3030-WCR	110380	GTA-110380	610-0084	GT-4084	1025-8	GTA-1025-8
3030LS-WCR	GTA-3030LS-WCR	110410	GTA-110410	640-0001	GT-4640H	1031-8	GTA-1031-8
BPS-3030	GTA-BC3030P	110415	GTA-110415	640-0003	GT-4640H	103-8	GTA-103-8
BPS-3030K	GTA-BC3030PK	110500	X-5	Sirco	Globetech	104-8	GTA-104-8
BPS-3030KLS	GTA-BC3030PLS	110515	GTA-110515	9013	GT-4020	106-8	GTA-106-8
BPS-2024	GTA-BC2024P	110700	GTA-110700	9015	GT-4020H	107-8	GTA-107-8
BPS-3036	GTA-BC3036P	110800	GTA-110800	9018	GT-4640	1106-8	GTA-1106-8
BSC-36	GTA-BC36	140270	GTA-140270	9020	GT-4640H	110-8	GTA-1107-8
BSC-30LS	GTA-BC30LS	140280	GTA-140280	333B	GT-46000A	116AB	GT-5257
30SC-WCR	GTA-BC30SC-WCR	996555	GTA-996555	B-9015	GT-4014	114-66	GT-5254
BSC-30	GTA-BC30	17600B	GTA-17600	B-9015V	GT-4014B	114B-44	GT-5255
BSC-24	GTA-BC24	17600B-1	GTA-17600B-1	Sirco	Globetech	115-86	GT-5253
BSC-20	GTA-BC20	Sloan	Globetech	9015	GT-4020H	115-88	GT-5251
BSC-16	GTA-BC16	42113	GT-3310	9018	GT-4640	161201-6	GTA-161201-6
BSC-12	GTA-BC12	44731	GT-5347	9020	GT-4640H	161201-8	GTA-161201-8
BSC-09	GTA-BC09	421010	GT-3309	333B	GT-46000A	17215-040	GTA-151214
RB-30DB	GTA-30DB	421145	GT-3324	B-9015	GT-4014	17A15-40H	GTA-151214X
RB006	GTA-006	421146	GT-3325	B-9015V	GT-4014B	17B12H	GTA-120606X
RB30PS	GTA-30PS	421164	GT-3315	Tectran	Globetech	17B15H	GTA-151212X
RB009	GTA-009	421165	GT-3316	102	GTA-102	17B20H	GTA-201212X
RB010	GTA-010	421166	GT-3306	103	GTA-103	181201-6	GTA-181201-6
RB-30DC	GTA-30DC	421172	GT-3307	104	GTA-104	181201-8	GTA-181201-8
RB008	GTA-008	421173	GT-3308	106	GTA-106	660-15	GT-3550
RB-9PR	GTA-9PR	421180	GT-3311	Tectran	Globetech	660-20	GT-3551
RB-12PR	GTA-12PR	421247	GT-3308	107	GTA-107	660-25	GT-3552
RB-16PR	GTA-16PR	590081	GT-3303	1021	GTA-1021	661-15	GT-3550P
RB-20PR	GTA-20PR	590161	GT-3304	1022	GTA-1022	661-20	GT-3551P
RB033	GTA-24PR	590163	GT-3300	1023	GTA-1023	661-25	GT-3552P
RB034	GTA-24PR	7R6122M	GT-3301	1024	GTA-1024	661-30	GT-3553P
RB-36PR	GTA-36PR	S60	GT-3302	1025	GTA-1025	667-7040	GT-3100
RB-9NPH	GTA-9NPH	S607	GT-3317	1031	GTA-1031	667-7050	GT-3101
RB-12NPH	GTA-12NPH	S608	GT-5251	1041	GTA-1041	670-11SG	GT-3001
RB-16NPH	GTA-16NPH	S609	GT-5254	1105	GTA-1105	670-12	GT-3010
RB-20NPH	GTA-20NPH	S620	GT-5256	1106	GTA-1106	670-21SG	GT-3002
RB-24NPH	GTA-24NPH	S629	GT-5257	1107	GTA-1107	670-22	GT-3012
RB020	GTA-30NPH	S661	GT-5253	5031	GT-3201	70-31402	GTA-5342
RB-36NPH	GTA-36NPH	Stemco	Globetech	9411	GT-5346NV	70-31403	GTA-5343
RB-D-9	GT-5205	330-3009	GT-4006	9412	GT-5346V	791-67	GT-3706
RB-D-16	GT-5206	330-3024	GT-4025	10111	GT-2600	7AAB122MG	GT-3306
RB-D-24	GT-5208	330-3067	GT-4004	10234	GTA-10234	7AAB152MG	GT-3307
RB-D-30	GT-5209	330-3077	GT-4021	17212	GTA-120606	7AAB202MG	GT-3308
RB-D-303	GT-5210	330-3118	GT-4008	17215	GTA-151212	7ATG222MG	GT-3300
RB-D-12	GT-5211	340-4009	GT-4009	17220	GTA-201212	7ATG522MG	GT-3301
RB-D-20	GT-5212	340-4013	GT-4013	101112	GT-2599	7ATG542MG	GT-3302
RB-D-243	GT-5213	340-4024	GT-4024	101113	GT-2604	7ATG622MW	GT-3303
RB-D-36	GT-5214	340-4075	GT-4075	101114	GT-2603	7ATG642MW	GT-3304
RB053	GTA-5280	340-4095	GT-4095	101118	GT-2608	7BTG222MG	GT-3324
RB9CK	GTA-5281	340-4195	GT-4195	105501	GTA-105501	7BTG522MG	GT-3325
RB12CK	GTA-5282	340-4370	GT-4370	107701	GTA-107701	7DTB222MW	GT-3326
RB16CK	GTA-5283						
RB20CK	GTA-5284						

DISCONTINUED

all references to competitors' part numbers are for cross reference purposes only



CROSS REFERENCE

Tectran	Globetech					Wabash	Globetech
7DTB522MW	GT-3327	36301	GT-5330	HTS356	GTK-356	004400035	GT-04400035
7ETB222MG	GT-3309	36390	GT-5350-90	HTS356	GTA-356	06300015	GT-1301
7ETB522MG	GT-3310	30004	GT-2312	HTS388	GTK-388	06300028	GT-1302
7ETB542MG	GT-3311	36101P	GT-5334X	HTS388	GTA-388	06300058	GT-1314
7R6122M	GT-3317	36201P	GT-5334X	HTS406	GTK-406	06300094	GT-1303
7SAB122MG	GT-3315	36301P	GT-5333X	HTS406	GTA-406	06300117	GT-1304
7SAB152MG	GT-3316	38502W	GT-3338	HTS419	GTK-419	06300118	GT-1305
80-1094	GTA-80-1094	50001	GT-5253	HTS419	GTA-419	06300119	GT-1306
80-1095	GTA-80-1095	50005	GT-5255	HTS456	GTK-456	063002201	GT-1334
832SPR	GT-3600	50006	GT-5254	HTS456	GTA-456	06300250	GT-1329
900R-32	GT-36281	50008	GT-5256	SC-1	GT-5256	06300693	GT-1307
9400D-2	GT-5380	50009	GT-5257	Todco	Globetech	06300805	GT-1308
9400D-2	GT-5380	50010	GT-5251	61196	GT-1401	06300844	GT-1315
9400E-2	GT-5370	50012	GT-5252	69035	GT-1400	06300844	GT-1316
9400E-2	GT-5370	56121	GT-5337	Tramec	Globetech	06300844	GT-1316
9400F-2	GT-5382	56221	GT-5336	30026	GT-2027	06301166	GT-1309
9400F-2	GT-5382	56321	GT-5335	30027	GT-2027	06301167	GT-1310
9400G-2	GT-5371	9202	GT-5339S	30037	GT-2044	06301217	GT-1318
9400G-2	GT-5371	9203	GT-5338S	30039	GT-2042	06301964	GT-1312
9400H-2	GT-5385	9211	GT-5339	30045	GT-2045	06302023	GT-1313
9400H-2	GT-5385	9212	GT-5338	36001	GT-2600	06302613	GT-1317
9400J-2	GT-5384	1010-F18	GT-5345	36003	GT-2599	10600526	GT-6200
9400J-2	GT-5384	Trailmobile	Globetech	36003	GT-5333	21300053	GT-2108
9400L-2	GT-5381	700-7-14	GT-4122	36133	GT-5354	21400170	GT-2100
9400L-2	GT-5381	700-7-15	GT-43068	36181	GT-5352-45	21400177	GT-2105
9400M-2	GT-5383	Trux	Globetech	36201	GT-5352-90	525461	GT-1328
9400M-2	GT-5383	LT77S	GT-2/LT77S	36201	GT-5331	61174	GT-1402
9420-1	GT-5379	Trucklite	Globetech	36201	GT-5351-90	70225	GT-1403
A148	GT-451065	80360	GT-7450	36233	GT-5353	A1300017	GT-1300
A824	GT-4130	97960	GT-1007	36281	GT-5351-45		
HTS225	GTK-225	97962	GT-1008				
HTS225	GTA-225	Utility	Globetech				
HTS275	GTK-275	03-1250-006	GT-UTM006				
HTS275	GTA-275	03-1250-025	GT-025				
HTS306	GTK-306	03-1250-053	GT-UTM053				
HTS306	GTA-306	03-1250-172	GT-UTM172				
HTS344	GTK-344	03-1250-214	GT-UTM214				
HTS344	GTA-344	03-1250-259	GT-UTM259				



INDEX

Part No.	Page No.	Part No.	Page No.	Part No.	Page No.
2406PSB.....	53	2605PSB.....	53	GT-1003.....	2
2406PSW.....	53	2605PSW.....	53	GT-1004.....	2
2424PHDB.....	29	A5247538.....	40	GT-1005.....	4
2424PHDW.....	29	D-312.....	40	GT-1006.....	2
2424PPSB.....	29	D-324.....	40	GT-1006A.....	2
2424PPSW.....	29	D-324A.....	40	GT-1007.....	2
2424PPSY.....	27	D-412.....	40	GT-1008.....	2
2424PSB.....	29	D-412A.....	40	GT-1009.....	2
2424PSBL.....	27	D-424.....	40	GT-1011.....	2
2424PSW.....	29	D-424A.....	40	GT-1035.....	3
2424PSY.....	27	D-472.....	40	GT-1035B.....	3
2424TPHDB.....	28	D-612.....	40	GT-1035L.....	3
2424TPPSB.....	28	D-624.....	40	GT-1050.....	3
2424TPSHDB.....	28	D-672.....	40	GT-1050L.....	3
2426PPSB.....	29	GEN2-0100.....	85-90	GT-1055.....	3
2427PPSB.....	29	GEN2-0101.....	85-90	GT-1055L.....	3
2427PPSW.....	29	GEN2-0180.....	85-90	GT-1100.....	5
2427PSB.....	29	GEN2-0210.....	85-90	GT-1100A.....	5
2427PSW.....	29	GEN2-0233.....	85-90	GT-1101.....	5
2427TPHDB.....	28	GEN2-0300.....	85-90	GT-1101A.....	5
2428PPSB.....	29	GEN2-0330.....	85-90	GT-1102.....	5
2428PPSW.....	29	GEN2-0470.....	85-90	GT-1105.....	4
2428PSW.....	29	GEN2-0584.....	85-90	GT-1106.....	16
2430PHDB.....	29	GEN2-0585.....	85-90	GT-1107.....	16
2430PHDW.....	29	GEN2-1010.....	85-90	GT-1108.....	6
2430PHDY.....	27	GEN2-1030.....	85-90	GT-1111.....	16
2430PPSB.....	29	GEN2-1031.....	85-90	GT-1150.....	5
2430PPSW.....	29	GEN2-2010.....	85-90	GT-1150W.....	5
2430PPSY.....	27	GEN2-2752.....	85-90	GT-1151.....	5
2430PSB.....	29	GEN2-2753.....	85-90	GT-1151W.....	5
2430PSBL.....	27	GEN2-3120.....	85-90	GT-1201.....	14
2430PSG.....	27	GEN2-5329.....	85-90	GT-1202.....	14
2430PSO.....	27	GEN2-5335.....	85-90	GT-12-038.....	139
2430PSR.....	27	GEN2-5336.....	85-90	GT-1217S.....	23
2430PSS.....	27	GEN2-5337.....	85-90	GT-1218S.....	23
2430PST.....	27	GEN2-5341.....	85-90	GT-1300.....	9
2430PSW.....	29	GEN2-5342.....	85-90	GT-1334.....	13
2430PSY.....	27	GEN2-5349.....	85-90	GT-1336.....	13
2430TPHDB.....	28	GEN2-5365.....	85-90	GT-1924S.....	23
2430TPPSB.....	28	GEN2-5374.....	85-90	GT-2000.....	39
2430TPPSW.....	28	GEN2-6010.....	85-90	GT-2006.....	39
2430TPSHDB.....	28	GEN2-6011.....	85-90	GT-2015S.....	23
2436PHDB.....	29	GEN2-801544.....	85-90	GT-2027.....	39
2436PHDW.....	29	GEN2-801545.....	85-90	GT-2036.....	41
2436PPSB.....	29	GEN2-801546.....	85-90	GT-2041.....	41
2436PPSW.....	29	GEN2-8154.....	85-90	GT-2042.....	39
2436PPSY.....	27	GEN2-AL91980.....	85-90	GT-2043.....	41
2436PSB.....	29	GEN2-AL919803.....	85-90	GT-2044.....	39
2436PSBL.....	27	GEN2-AL919806.....	85-90	GT-2045.....	41
2436PSG.....	27	GT-025.....	42	GT-2046.....	41
2436PSO.....	27	GT-04400035.....	4	GT-2047D.....	38
2436PSR.....	27	GT-1002.....	4	GT-2047L.....	38
2436PSW.....	29	GT-1002A.....	4	GT-2048D.....	38
2436TPHDB.....	28	GT-1002F.....	4	GT-2049.....	38
2436TPSHDB.....	28	GT-1002L.....	4	GT-2050.....	38
2436TPPSB.....	28			GT-2052D.....	38

all references to competitors' part numbers
are for cross reference purposes only

INDEX

Part No.	Page No.	Part No.	Page No.	Part No.	Page No.
GT-2057.....	38	GT-2604.....	137	GT-27B6728SS.....	49
GT-2099.....	40	GT-2605GLO.....	136	GT-27B67C.....	49
GT-2100.....	42	GT-2605WS.....	136	GT-27B67SS.....	49
GT-2101.....	42	GT-2606.....	137	GT-27B68.....	49
GT-2102.....	42	GT-2607.....	137	GT-27B68C.....	49
GT-2103.....	42	GT-2608.....	137	GT-27B68SS.....	49
GT-2104.....	42	GT-2609.....	136	GT-27B7.....	50
GT-2105.....	42	GT-2610.....	139	GT-27B700.....	45
GT-2106.....	42	GT-2613.....	42	GT-27B71.....	50
GT-2107.....	42	GT-27000.....	47	GT-27B711.....	45
GT-2108.....	42	GT-27003.....	7,47	GT-27B71C.....	50
GT-2109.....	42	GT-27004.....	7,47	GT-27B71SS.....	50
GT-2312.....	39	GT-27005.....	7,47	GT-27B7C.....	50
GT-2345.....	39	GT-27006.....	7,47	GT-27B7SS.....	50
GT-2406.....	53	GT-27007.....	7,47	GT-27K700.....	45
GT-2414S.....	23	GT-2701C.....	45	GT-27K711.....	45
GT-2418S.....	23	GT-2701SS.....	45	GT-27LT778.....	50
GT-2424-AS.....	25	GT-2702C.....	45	GT-27P125.....	4
GT-2424C.....	22	GT-2702SS.....	45	GT-27RT35.....	4
GT-2424CD.....	21	GT-27051.....	46	GT-3001.....	60
GT-2424D.....	19	GT-27053.....	46	GT-3001A.....	60
GT-2424GFB.....	18	GT-27069.....	47	GT-3002.....	60
GT-2424HDD.....	25	GT-27150.....	48	GT-3004.....	60
GT-2424S.....	23	GT-2721B.....	44	GT-3005.....	60
GT-2424XD.....	24	GT-2723B.....	43	GT-3006A.....	60
GT-2430AS.....	25	GT-2725A.....	43	GT-3006B.....	60
GT-2430C.....	22	GT-2725B.....	43	GT-3007.....	99
GT-2430CD.....	21	GT-2725B70.....	46	GT-3007A.....	60
GT-2430D.....	19	GT-27270.....	48	GT-3007B.....	60
GT-2430GFB.....	18	GT-27271.....	48	GT-3007E.....	60
GT-2430HDD.....	25	GT-2729B.....	43	GT-3017.....	65
GT-2430M.....	26	GT-2730B.....	43	GT-3017-15.....	65
GT-2430RT.....	26	GT-2735A.....	43	GT-3017-15P.....	65
GT-2430S.....	23	GT-2735B.....	43	GT-3017-20.....	65
GT-2430XD.....	24	GT-2735B70.....	43	GT-3017-20P.....	65
GT-2436A.....	22	GT-27404.....	48	GT-3017-30.....	65
GT-2436C.....	22	GT-27516.....	46	GT-3017-30P.....	65
GT-2436CD.....	21	GT-27517.....	46	GT-3017-G.....	65
GT-2436E.....	19	GT-2781A.....	44	GT-3100.....	62
GT-2436HDD.....	25	GT-2781B.....	44	GT-3101.....	62
GT-2436M.....	26	GT-2782A.....	44	GT-3200.....	63
GT-2436S.....	23	GT-2782B.....	44	GT-3201.....	66
GT-2436XD.....	24	GT-2783B.....	44	GT-3203.....	65
GT-2440HDD.....	25	GT-2784B.....	44	GT-3203C.....	65
GT-2440XD.....	24	GT-27864.....	48	GT-3203-D.....	65
GT-2442HDD.....	25	GT-27865.....	48	GT-3203-G.....	65
GT-2442XD.....	24	GT-27868.....	48	GT-3204.....	65
GT-2599.....	137	GT-27870.....	48	GT-3204-C.....	65
GT-2600.....	137	GT-27B57.....	49	GT-3204-D.....	65
GT-2601.....	137	GT-27B5728.....	49	GT-3204-G.....	65
GT-2601WS.....	137	GT-27B5728SS.....	49	GT-3227.....	57
GT-2602.....	137	GT-27B57SS.....	49	GT-3227E.....	57
GT-2602WS.....	137	GT-27B67.....	49	GT-3300.....	57
GT-2603.....	137	GT-27B6728.....	49	GT-3301.....	57
GT-2603WS.....	137	GT-27B6728C.....	49	GT-3302.....	57

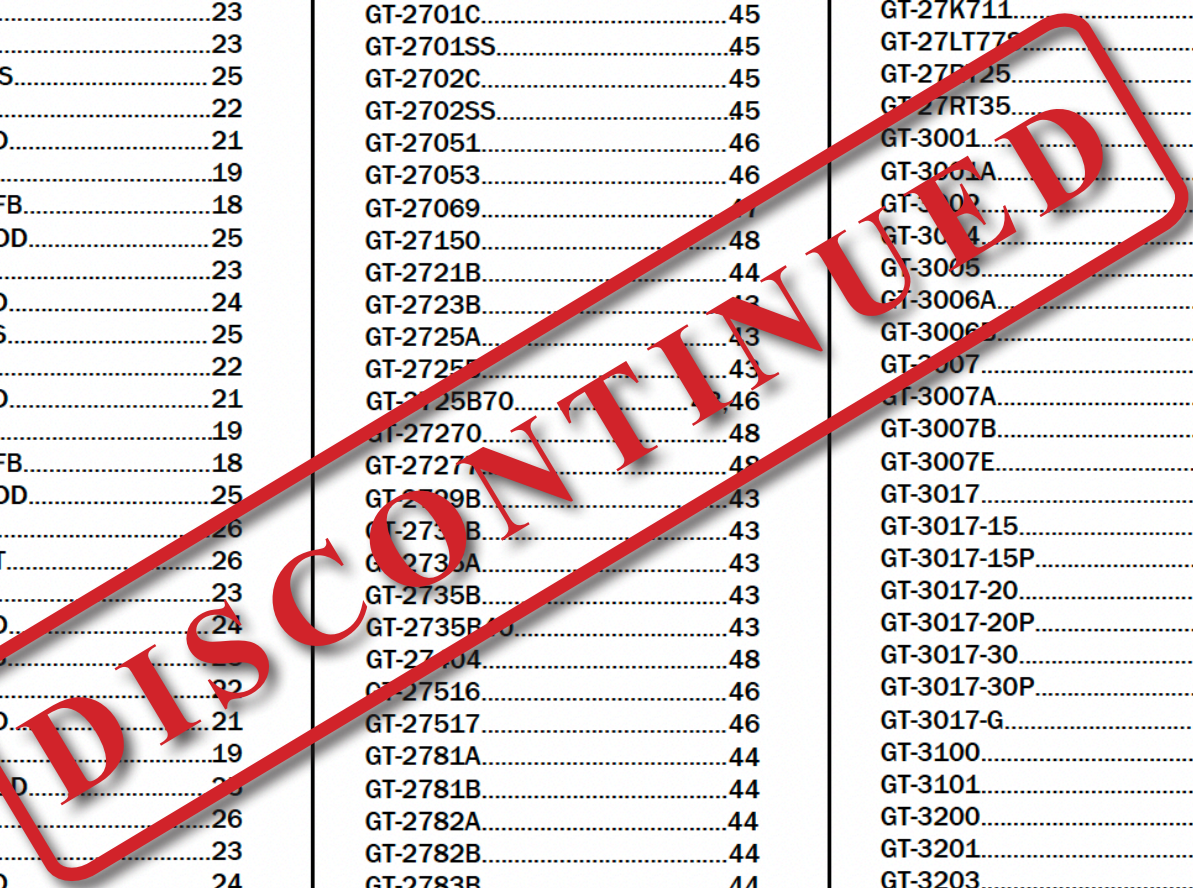

all references to competitors' part numbers are for cross reference purposes only

INDEX

Part No.	Page No.	Part No.	Page No.	Part No.	Page No.
GT-3303	57	GT-3714	63	GT-4020H	72
GT-3304	57	GT-3715	63	GT-4021	73
GT-3306	57	GT-3715W	63	GT-4024	70
GT-3307	57	GT-3801	67	GT-4024S	70
GT-3308	57	GT-3802	67	GT-4025	70,74
GT-3309	58	GT-3802-R	67	GT-4040	80
GT-3310	58	GT-3802-G	67	GT-4065	71
GT-3311	58	GT-3804	67	GT-4075	71
GT-3315	58	GT-3805	67	GT-4084	71
GT-3316	58	GT-3806	67	GT-4095	71
GT-3317	58	GT-3807	67	GT-4095S	71
GT-3320	99	GT-3808	67	GT-4101	80
GT-3321	99	GT-3809	67	GT-4120	79
GT-3322	99	GT-3810	67	GT-4121	79
GT-3324	59	GT-3900	52	GT-4122	79
GT-3325	59	GT-391300	54	GT-41226	77
GT-3326	59	GT-391301	54	GT-4123	79
GT-3327	59	GT-391585	54	GT-4195	70
GT-33333	N/A	GT-391590	54	GT-4195G	70
GT-3337	61	GT-391600	55	GT-4195N	70
GT-3338	61	GT-391601	55	GT-4195S	70
GT-3338G	61	GT-391625	55	GT-4224XD	27
GT-3400	66	GT-391626	54	GT-4295	71
GT-3401	66	GT-39414	53	GT-4300	80
GT-3402	64	GT-39415	53	GT-43068	77
GT-3403	64	GT-39416	53	GT-4370	78
GT-3550	66	GT-395000	55	GT-4370	78
GT-3551	66	GT-395001	55	GT-4372	78
GT-3552	66	GT-39585B	51	GT-4372S	78
GT-3553	66	GT-39585FB	51	GT-443638	27
GT-3600	99	GT-39585M	52	GT-45130	81
GT-3604YD	66	GT-4000	69,73	GT-45135	81
GT-3607	66	GT-4001	73	GT-451065	81
GT-3612	62	GT-4001BLK	73	GT-46000A	77
GT-3613	62	GT-4001RED	73	GT-4640	71
GT-3614	62	GT-4002	69,73	GT-4912	71,73
GT-3614-2	62	GT-4003	69	GT-4AG2106	77
GT-3615	62	GT-4004	74	GT-4AG2107	77
GT-3615	62	GT-4005	73	GT-4AG2111	77
GT-3624	62	GT-4006	69,74	GT-4E5568L	76
GT-36044	64	GT-4007	70	GT-4E5568R	77
GT-36064	64	GT-4007F	70,74	GT-4E5977L	78
GT-36084	64	GT-4008	69	GT-4E5977R	79
GT-36104	64	GT-4009	69	GT-4E5988L	80
GT-36124	64	GT-4009G	69	GT-4E5988R	81
GT-36164	64	GT-4009H	69	GT-4E7895L	82
GT-36241	64	GT-4009K	69	GT-4E7895R	83
GT-36271	64	GT-4009P	69	GT-4E7896L	84
GT-36281	64	GT-4009S	69	GT-4E7896R	85
GT-36291	64	GT-4009SK	69	GT-5001	107
GT-36301	64	GT-4013	70	GT-5001-2	108
GT-36302	64	GT-4014	73	GT-5001-3	108
GT-36304	64	GT-4014B	73	GT-5001-4	108
GT-3704YD	63	GT-4020	72	GT-5002	107
GT-3706	63	GT-4020B	72	GT-5003	107
GT-3707YD	63			GT-5004	107



all references to competitors' part numbers are for cross reference purposes only

INDEX

Part No.	Page No.	Part No.	Page No.	Part No.	Page No.
GT-5006.....	107	GT-5345FX.....	138	GT-7100.....	144
GT-5007.....	107	GT-5346NV.....	138	GT-7100R.....	144
GT-5008.....	107	GT-5346V.....	138	GT-7100WR.....	144
GT-5010.....	108	GT-5347.....	138	GT-7101.....	144
GT-5011.....	108	GT-5350.....	134	GT-7101WR.....	144
GT-5012.....	108	GT-5351-45.....	134	GT-7200.....	138
GT-5014.....	107	GT-5351-90.....	134	GT-7200-E100.....	138
GT-5014A.....	107	GT-5351P-45.....	134	GT-7200-E101.....	138
GT-5015.....	107	GT-5351P-90.....	134	GT-7201.....	143
GT-5016A.....	107	GT-5352-45.....	134	GT-7201-E100.....	143
GT-5031.....	107	GT-5352-90.....	134	GT-7202-01.....	143
GT-5205.....	95	GT-5352P-45.....	134	GT-7202-01K.....	143
GT-5206.....	95	GT-5352P-90.....	134	GT-7202-02.....	143
GT-5208.....	95	GT-5370.....	109	GT-7202-02K.....	143
GT-5209.....	95	GT-5371.....	109	GT-7202-05.....	143
GT-5210.....	95	GT-5372.....	109	GT-7202-05K.....	143
GT-5211.....	95	GT-5373.....	136	GT-7202-0611K.....	107
GT-5212.....	95	GT-5374.....	136	GT-7208.....	107
GT-5213.....	95	GT-5375.....	107	GT-7460.....	68
GT-5214.....	95	GT-5375A.....	107	GT-7461.....	68
GT-5251.....	106	GT-5376.....	99	GT-7600B.....	68
GT-5252.....	106	GT-5379.....	99	GT-7600BLK.....	75
GT-5253.....	106	GT-5380.....	109	GT-7600GLOBE ECH.....	75
GT-5254.....	106	GT-5381.....	109	GT-7710.....	75
GT-5255.....	106	GT-5382.....	109	GT-7711.....	64
GT-5256.....	106	GT-5383.....	109	GT-7712.....	64
GT-5257.....	106	GT-5384.....	109	GT-7713.....	64
GT-5280.....	95	GT-5385.....	109	GT-8405.....	64
GT-5281.....	95	GT-5391.....	99, 108	GT-8500.....	27
GT-5282.....	95	GT-5392.....	99, 108	GT-9014.....	144
GT-5283.....	95	GT-5400.....	110	GT-9015.....	37
GT-5284.....	95	GT-5400A.....	110	GT-9016.....	37
GT-5285.....	95	GT-5400B.....	110	GT-9017.....	37
GT-5286.....	95	GT-5400C.....	110	GT-9017B.....	37
GT-5300.....	105	GT-5401.....	110	GT-9017PPB.....	37
GT-5317.....	135	GT-5402.....	110	GT-9017PPY.....	37
GT-5327.....	135	GT-5402A.....	110	GT-9019.....	37
GT-533.....	134	GT-5402B.....	110	GT-9020L.....	37
GT-5330.....	134	GT-5403.....	110	GT-9020R.....	37
GT-5331.....	134	GT-5404.....	110	GT-9021L.....	37
GT-5331A.....	134	GT-5405.....	110	GT-9021R.....	37
GT-5332.....	134	GT-5406.....	110	GT-9023.....	37
GT-5332A.....	134	GT-5421.....	106	GT-9024.....	37
GT-5335.....	136	GT-5422.....	106	GT-9025.....	37
GT-5336.....	136	GT-5423.....	106	GT-9026.....	37
GT-5337.....	137	GT-5424.....	106	GT-9032B.....	37
GT-5338.....	135	GT-5425.....	106	GT-9032W.....	37
GT-5338S.....	135	GT-5426.....	106	GT-9034.....	37
GT-5339.....	135	GT-5427.....	107	GT-9035.....	37
GT-5339S.....	135	GT-5500-12.....	108	GT-9036.....	37
GT-5340.....	140	GT-5500-38.....	108	GT-TE382.....	37
GT-5341.....	140	GT-5501-12.....	108	GT-TL610.....	82
GT-5342TB.....	140	GT-5501-38.....	108	GT-TR501.....	83
GT-5343.....	140	GT-611K.....	138	GT-TR509.....	82
GT-5345.....	138	GT-7001.....	144	GT-TR510.....	82

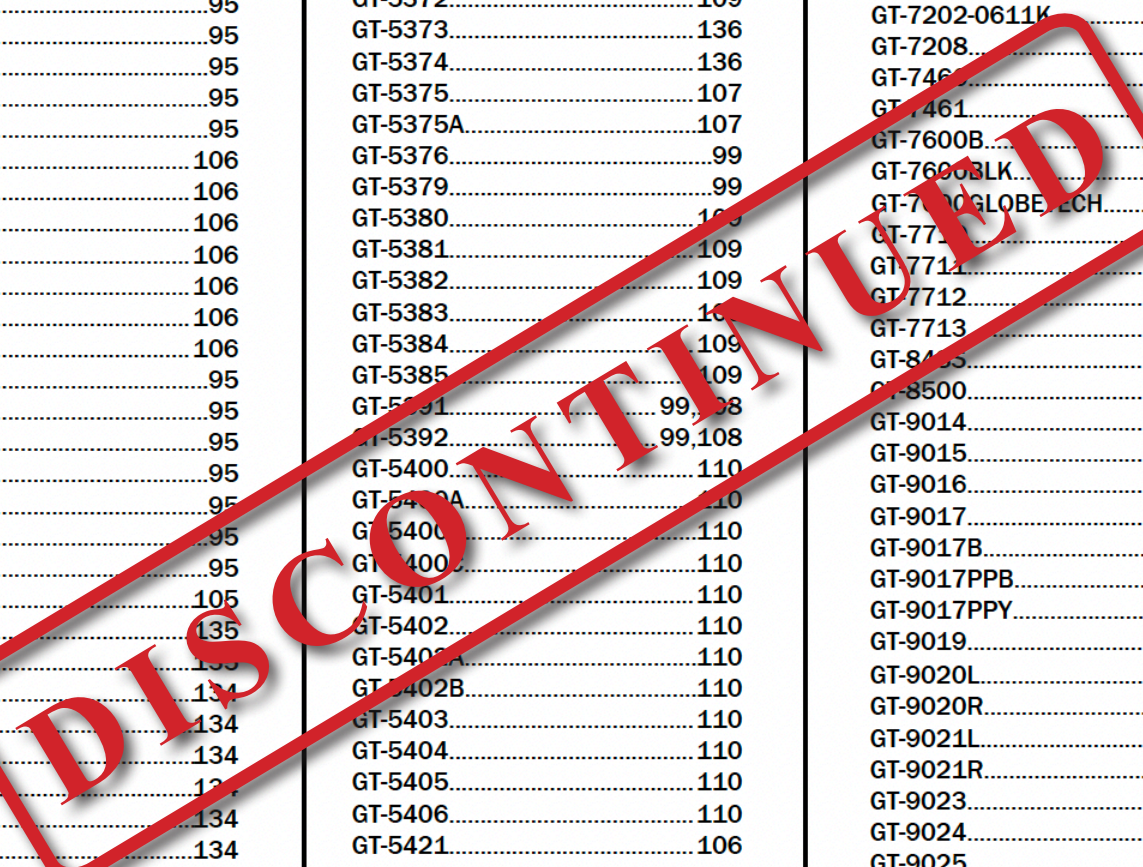

all references to competitors' part numbers are for cross reference purposes only

INDEX

Part No.	Page No.	Part No.	Page No.	Part No.	Page No.
GT-TR544D.....	82	GTA-1031-8.....	102	GTA-1238F45.....	101
GT-TR545D.....	82	GTA-104.....	102	GTA-1238F46.....	101
GT-TR572.....	82	GTA-104-8.....	102	GTA-1238F48.....	101
GT-TR573.....	82	GTA-1041.....	102	GTA-1238F50.....	101
GT-UTM006.....	39	GTA-1041-8.....	102	GTA-1238F52.....	101
GT-UTM053.....	39	GTA-105.....	102	GTA-1238F54.....	101
GT-UTM172.....	39	GTA-105501.....	103	GTA-1238F56.....	101
GT-UTM214.....	39	GTA-106.....	102	GTA-1238F60.....	101
GT-UTM259.....	39	GTA-106-8.....	102	GTA-1238F66.....	101
GT-VC-1.....	83	GTA-107.....	102	GTA-1238F72.....	101
GT-VC-3.....	83	GTA-107-8.....	102	GTA-1238F84.....	101
GT-VC-8.....	83	GTA-107695.....	131	GTA-1238S08.....	101
GTA-006.....	94	GTA-1077011.....	103	GTA-1238S11.....	101
GTA-010.....	94	GTA-107796.....	131	GTA-1238S12.....	101
	94	GTA-107799.....	131	GTA-1238S14.....	101
	94	GTA-107800.....	131	GTA-1238S16.....	101
GTA-065066.....	125	GTA-109493.....	131	GTA-1238S18.....	101
GTA-065067.....	125	GTA-109495.....	133	GTA-1238S20.....	101
GTA-065104.....	126	GTA-109578.....	131	GTA-1238S22.....	101
GTA-065145.....	127	GTA-109579.....	131	GTA-1238S24.....	101
GTA-065146.....	127	GTA-109869.....	131	GTA-1238S26.....	101
GTA-065164.....	114	GTA-109994.....	133	GTA-1238S28.....	101
GTA-065167.....	114	GTA-110170.....	129	GTA-1238S30.....	101
GTA-065170.....	114	GTA-110171.....	129	GTA-1238S32.....	101
GTA-065172.....	114	GTA-110197.....	128	GTA-1238S34.....	101
GTA-065174.....	114	GTA-110200.....	127	GTA-1238S36.....	101
GTA-065175.....	114	GTA-110205.....	127	GTA-1238S38.....	101
GTA-065178.....	114	GTA-110415.....	128	GTA-1238S40.....	101
GTA-065179.....	114	GTA-1105.....	102	GTA-1238S42.....	101
GTA-065225.....	131	GTA-110570.....	122	GTA-1238S44.....	101
GTA-065437.....	129	GTA-1106.....	102	GTA-1238S46.....	101
GTA-065439.....	129	GTA-1107-8.....	102	GTA-1238S48.....	101
GTA-065612.....	131	GTA-1107.....	102	GTA-1238S50.....	101
GTA-1003100.....	133	GTA-1108-8.....	102	GTA-1238S52.....	101
GTA-101112.....	130	GTA-12000.....	100	GTA-1238S54.....	101
GTA-101622.....	130	GTA-120606.....	97	GTA-1238S56.....	101
GTA-102.....	102	GTA-120606X.....	98	GTA-1238S60.....	101
GTA-1021.....	102	GTA-12352.....	127	GTA-1238S66.....	101
GTA-1022.....	103	GTA-1238F08.....	101	GTA-1238S72.....	101
GTA-1022-8.....	103	GTA-1238F12.....	101	GTA-1238S80.....	101
GTA-1023.....	103	GTA-1238F14.....	101	GTA-1238S84.....	101
GTA-1023-8.....	103	GTA-1238F16.....	101	GTA-12PR.....	94
GTA-10234.....	103	GTA-1238F18.....	101	GTA-131081.....	128
GTA-10234.....	103	GTA-1238F20.....	101	GTA-151212.....	97
GTA-1024.....	103	GTA-1238F22.....	101	GTA-151212X.....	98
GTA-1024-8.....	103	GTA-1238F24.....	101	GTA-151213.....	97
GTA-1025.....	103	GTA-1238F26.....	101	GTA-151213X.....	98
GTA-1025-8.....	103	GTA-1238F28.....	101	GTA-151214.....	97
GTA-102626.....	126	GTA-1238F30.....	101	GTA-16201.....	102
GTA-102761.....	130	GTA-1238F32.....	101	GTA-161201-6.....	102
GTA-103.....	102	GTA-1238F34.....	101	GTA-161201-8.....	102
GTA-103009.....	126	GTA-1238F36.....	101	GTA-16743.....	121
GTA-103010.....	126	GTA-1238F38.....	101	GTA-16NPH.....	94
GTA-103028.....	126	GTA-1238F40.....	101	GTA-16PR.....	94
GTA-103-8.....	102	GTA-1238F42.....	101	GTA-17600.....	121
GTA-1031.....	102	GTA-1238F44.....	101	GTA-181201.....	102

all references to competitors' part numbers
are for cross reference purposes only

INDEX

Part No.	Page No.	Part No.	Page No.	Part No.	Page No.
GTA-181201-6	102	GTA-26000	125	GTA-3838F22	101
GTA-181201-8	102	GTA-27000	124	GTA-3838F24	101
GTA-1922-01-1	104	GTA-276566	122	GTA-3838F26	101
GTA-19225-01-1	104	GTA-276567	122	GTA-3838F28	101
GTA-1923-01-1	104	GTA-277863	121	GTA-3838F30	101
GTA-1924-01-1	104	GTA-278614	122	GTA-3838F32	101
GTA-1924-02-1	104	GTA-278615	122	GTA-3838F34	101
GTA-1924-04-1	104	GTA-279000	130	GTA-3838F36	101
GTA-1924-05-1	104	GTA-279472	124	GTA-3838F38	101
GTA-1924-07-1	104	GTA-280479	122	GTA-3838F40	101
GTA-1926-01-1	104	GTA-281865	127	GTA-3838F42	101
GTA-1926-02	104	GTA-284143	129	GTA-3838F44	101
GTA-1926-02-1	104	GTA-284412	121	GTA-3838F45	101
GTA-1926-04-1	104	GTA-28500	127	GTA-3838F46	101
GTA-1926-05	104	GTA-28510	127	GTA-3838F48	101
GTA-1926-05-1	104	GTA-28520	127	GTA-3838F50	101
GTA-1926-07-1	104	GTA-28600	123	GTA-3838F52	101
GTA-1928-01	104	GTA-28601	123	GTA-3838F54	101
GTA-1928-01-1	104	GTA-286171	121	GTA-3838F56	101
GTA-1928-02	104	GTA-286364	129	GTA-3838F60	101
GTA-1928-02-1	104	GTA-286370	128	GTA-3838F66	101
GTA-1928-05	104	GTA-286771	121	GTA-3838F72	101
GTA-1928-05-1	104	GTA-286773	121	GTA-3838F84	101
GTA-1928-07-1	104	GTA-288239	125	GTA-3838S08	101
GTA-1930-01-1	104	GTA-289182	126	GTA-3838S12	101
GTA-1932-01-1	104	GTA-289714	126	GTA-3838S14	101
GTA-20030	123	GTA-30300	128	GTA-3838S16	101
GTA-20031	123	GTA-30400	128	GTA-3838S18	101
GTA-201212	97	GTA-30DB	94	GTA-3838S20	101
GTA-201212X	98	GTA-30DC	94	GTA-3838S22	101
GTA-205105	129	GTA-30NPH	94	GTA-3838S24	101
GTA-20541	123	GTA-30PR	94	GTA-3838S26	101
GTA-20NPH	94	GTA-31527	133	GTA-3838S28	101
GTA-20PR	94	GTA-33100	132	GTA-3838S30	101
GTA-21102	118	GTA-34100	118	GTA-3838S32	101
GTA-21103	118	GTA-34200	118	GTA-3838S34	101
GTA-22102	118	GTA-35100	118	GTA-3838S36	101
GTA-22103	118	GTA-35200	118	GTA-3838S38	101
GTA-224	133	GTA-3546	125	GTA-3838S40	101
GTA-224-2	133	GTA-36NPF	94	GTA-3838S42	101
GTA-23102	118	GTA-36PR	94	GTA-3838S44	101
GTA-24100	118	GTA-38000	100	GTA-3838S46	101
GTA-24102	118	GTA-3812F144		GTA-3838S48	101
GTA-24103	118	GTA-3812F144B		GTA-3838S50	101
GTA-24NPH	94	GTA-3812F144R		GTA-3838S52	101
GTA-24PR	94	GTA-3812F180		GTA-3838S54	101
GTA-25100	118	GTA-3812F180B		GTA-3838S56	101
GTA-25102	118	GTA-3812F180R		GTA-3838S60	101
GTA-25103	118	GTA-3812F240		GTA-3838S66	101
GTA-228600	130	GTA-3838F08	101	GTA-3838S72	101
GTA-228750	124	GTA-3838F12	101	GTA-3838S84	101
GTA-229635	122	GTA-3838F120	101	GTA-40010140	115
GTA-229859	126	GTA-3838F14	101	GTA-40010141	115
GTA-229860	126	GTA-3838F16	101	GTA-40010142	115
GTA-23000	122	GTA-3838F18	101	GTA-40010143	115
GTA-23800	122	GTA-3838F20	101	GTA-40010144	115

all references to competitors' part numbers
are for cross reference purposes only

INDEX

Part No.	Page No.	Part No.	Page No.	Part No.	Page No.
GTA-40010211.....	117	GTA-R801074.....	114		
GTA-40010212.....	117	GTA-SC1.....	105		
GTA-40010214.....	117	GTK-20015.....	146		
GTA-40010215.....	116				
GTA-40010216.....	116				
GTA-40010305.....	116				
GTA-40010306.....	116				
GTA-41100.....	118				
GTA-41106.....	118				
GTA-42100.....	118				
GTA-42106.....	118				
GTA-43100.....	118				
GTA-43016.....	118				
GTA-5001247.....	131				
GTA-5342.....	105				
GTA-5343.....	105				
GTA-800404.....	131				
GTA-800405.....	131				
GTA-80-1094.....	139				
GTA-80-1095.....	139				
GTA-90054007.....	124				
GTA-90054074.....	129				
GTA-90054075.....	129				
GTA-90054076.....	129				
GTA-90054079.....	129				
GTA-90054088KIT.....	125				
GTA-90054107.....	125				
GTA-90554241.....	124				
GTA-90554243.....	124				
GTA-910058.....	124				
GTA-A10005.....	128				
GTA-A4688.....	130				
GTA-A4740.....	123				
GTA-A5000.....	130				
GTA-BC2024.....	93				
GTA-BC24.....	93				
GTA-BC2424.....	93				
GTA-BC2424LS.....	93				
GTA-BC2430.....	93				
GTA-BC2430LS.....	93				
GTA-BC30.....	93				
GTA-BC3030.....	93				
GTA-BC3030LS.....	93				
GTA-BC3030PK.....	93				
GTA-BC3030PLSK.....	93				
GTA-BC3030V.....	93				
GTA-BC3036.....	93				
GTA-BC30LS.....	93				
GTA-BC30N.....	93				
GTA-BC30SC-WCR.....	93				
GTA-BC3636.....	93				
GTA-G8602.....	123				
GTA-K022105.....	131				
GTA-M7102.....	123				
GTA-M7102-K.....	123				
GTA-R801073.....	114				

all references to competitors' part numbers
are for cross reference purposes only

WARRANTY POLICY

GLOBETECH Manufacturing warrants its products to be free from manufacturing defects for a period of one year from date of shipment. Buyer's exclusive remedy and seller's sole liability hereunder shall be limited to refund of the purchase price or replacement of the product shown to be other than as warranted. Conditions resulting from misuse, negligence, alteration, accident, or improper installation, maintenance, or application shall absolve seller of all liability. The foregoing constitutes the sole warranty of GLOBETECH Manufacturing with respect to its products and in lieu of all other warranties, expressed or implied, including any implied warranties of merchantability or of the fitness for a particular purpose. In no event and under no circumstances, shall GLOBETECH Manufacturing be liable for consequential or special damages.

RETURN POLICY

GLOBETECH Manufacturing will only allow returns upon approval and each return is subject to 25% restocking fee. Custom-made products may not be returned. Each return requires an RGA number issued by GLOBETECH Manufacturing. Customers must pay freight on all returns, and package items in such a way that makes our RGA number clear and obvious. All products must be in excellent condition, suitable for resale. We reserve the right to refuse any and all requests for product returns, based on poor condition of product, or on obsolescence of a particular item or product line. Credit for returns shall be in the form of a credit to customers account for use against further purchase.



Phone: 937-274-5587 Fax: 937-274-6102 www.gtmanufacturing.com



72,000 SQ FT
Dedicated to Manufacturing and
Distribution. Dayton, Ohio

40,000 SQ FT
Packaging and Distribution

12,000 SQ FT
Mudflap Production

20,000 SQ FT
Brake Chamber Assembly
Brake Hose Assembly
Testing
Administrative

Proudly manufacturing and distributing
Truck & Trailer parts since 1992.

Thank You For Your Business

President,
Tim Begley



Corporate Office Dayton, Ohio

